

# Chongqing International Construction Corporation (CICO)

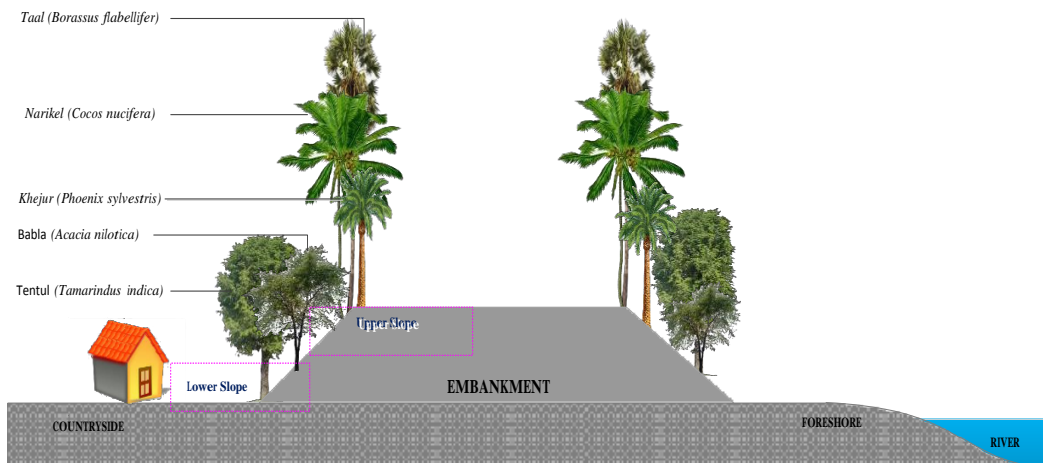

## Coastal Embankment Improvement Project, Phase-1 (CEIP-1)



## Contractor's Environmental and Social Management Plan (C-ESMP) for Polder 40/2

Version-5 (Updated version)  
May 2022

## Abbreviations and Acronyms

BOD	Biochemical Oxygen Demand
BWDB	Bangladesh Water Development Board
C-ESMP	Contractor's Environmental and Social Management Plan
CEGIS	Centre for Environmental and Geographic Information Services
CEIP	Coastal Embankment Improvement Program
CEIP-1	Coastal Embankment Improvement Project, Phase-1
DDCS&PMSC	Detailed Design, Construction Supervision and Project Management Support Consultant
DOE	Department of Environment
DPHE	Department of Public Health Engineering
EC	Electrical Conductivity
EHS	Environmental Health and Safety
EIA	Environmental Impact Assessment
EMP	Environmental Management Plan
FIDIC	International Federation of Consulting Engineers
GoB	Government of Bangladesh
GRC	Grievance Redress Committee
GRM	Grievance Redress Mechanism
IFC	International Finance Corporation
NGO	Non-Governmental Organization
NTU	Nephelometric Turbidity Unit
PAP	Project Affected Person
PMSC	Project Management Support Consultant
PPE	Personnel Protective Equipment
PRO	Public Relation Officer
RAP	Resettlement Action Plan
RCC	Reinforced Concrete Cement
SLR	Sea Level Rise
SOx	Sulfur Oxides
TDS	Total Dissolve Solids
UP	Union Parishad (administrative unit in Bangladesh)
WB	World Bank

## Contents

<b>Abbreviations and Acronyms</b> .....	<b>2</b>
<b>Contents</b> .....	<b>3</b>
<b>1 Introduction</b> .....	<b>6</b>
1.1 The Project .....	6
1.2 Project Activities .....	7
1.3 Purpose of the Contractor's Environmental and Social Management Plan .....	7
1.4 Scope of the Contractor's Environmental and Social Management Plan.....	8
<b>2 Environmental and Social Actions as per Project Component</b> .....	<b>9</b>
2.1 Temporary Facilities.....	9
2.1.1 Site office / Workers' Camp/ Regional office.....	9
2.1.2 Fuel supplies for cooking and heating purposes.....	10
2.1.3 By-pass Road Construction .....	11
2.1.4 Sanitation .....	11
2.1.5 Water Supply.....	12
2.1.6 Temporary Facilities Decommissioning.....	12
2.2 Construction Works .....	13
2.2.1 Construction and re-sectioning of embankments.....	13
2.2.2 Demolishing and Construction of drainage sluices, flushing sluices, inlets and flood walls .....	15
2.2.3 The bank and slope protection works . Mitigation measures for barge are addressed for 4 Polders except Polders 40/2 & 48. Bank protection work is not included in Polders 40/2 & 48.....	16
2.2.4 Re-excavation of drainage channels .....	17
2.2.5 Manufacture of pre-cast CC blocks .....	17
2.2.6 Chemicals and Fuel Storage Areas .....	21
2.3 Waste .....	21
2.3.1 Non-hazardous Solid Waste.....	21
2.3.2 Hazardous Waste .....	22
2.4 Waste water.....	22
2.5 Occupational Health and Safety .....	23
2.6 Public Health and Safety .....	23
2.7 Cultural Properties .....	24
2.8 Flora and Fauna Management.....	24
2.9 Soil Management .....	25
2.10 Electrical Safety.....	26
2.11 Labour Influx .....	26
<b>3 Actions as per Environmental and Social Aspect</b> .....	<b>27</b>
3.1 Occupational Health and Safety .....	27
3.2 Public Health and Safety .....	27
3.3 Cultural Properties .....	28
3.4 Solid Waste Management.....	29
3.4.1 Non-hazardous Solid Waste.....	29

3.4.2	Hazardous Waste .....	29
	Fuel/Chemical storage Areas .....	30
3.5	Waste water .....	30
3.6	Air Emissions .....	31
3.7	Noise Management.....	31
3.8	Water Management.....	32
3.9	Flora and Fauna Management .....	32
3.10	Soil Management .....	35
3.11	Payment of Wages .....	35
3.12	Code of conduct .....	35
3.13	Construction and re-sectioning of embankments .....	35
3.14	Demolishing and Construction of drainage sluices, flushing sluices and inlets.....	37
3.15	The bank and slope protection works .....	38
3.16	Re-excavation of drainage channels .....	39
3.17	Risk Assessment for new/additional activities.....	40
	Description of construction activities .....	40
<b>4</b>	<b>Environmental Mitigation Works .....</b>	<b>42</b>
4.1	Non-Compliance Rectification Process .....	42
<b>5</b>	<b>Social Mitigation measure .....</b>	<b>43</b>
5.1	Land Acquisition.....	43
5.2	Squatter Displacement .....	43
5.3	Labor Influx .....	43
5.4	Tree cutting/felling .....	44
5.5	Discussion with local population in pre- work and during work .....	44
5.6	during work.....	44
5.7	Grievance Redress Mechanism.....	44
5.7.1	GRM for General Public.....	44
5.7.2	GRM for Workers .....	44
<b>6</b>	<b>Environmental Management Organization.....</b>	<b>45</b>
6.1	Schedule for different meetings .....	47
6.2	Schedule of different trainings .....	48
<b>7</b>	<b>Monitoring, Reporting and Record Keeping .....</b>	<b>Error! Bookmark not defined.</b>
<b>8</b>	<b>Contingency Planning .....</b>	<b>62</b>
<b>9</b>	<b>Contractor's Environmental and Social Management Plan Monitoring Checklist.....</b>	<b>63</b>
	<b>Annex-1: Overview Works Polder-40/2.....</b>	<b>64</b>
	<b>Annex-2: Update progress CEIP-1 Contract W-02 .....</b>	<b>65</b>
	<b>Annex-3: Monitoring Checklist for General Site Mobilization Work and CC block manufacturing plant.....</b>	<b>66</b>
	<b>Annex-5: Monitoring Checklist for the bank and slope protection works .....</b>	<b>88</b>
	<b>Annex-6: Monitoring Checklist for Construction and demolishing of drainage sluices/flushing sluices .....</b>	<b>97</b>
	<b>Annex-7: Monitoring Checklist for Re-excavation of Khal .....</b>	<b>108</b>
	<b>Annex-8: Monitoring Checklist for Construction of Flood Wall .....</b>	<b>115</b>
	<b>Annex-9: Monitoring Checklist for Afforestation .....</b>	<b>124</b>

---

<b>Annex-10: Monitoring Checklist for Demobilization work .....</b>	<b>127</b>
<b>Annex-11: Lay out plan for Construction Camp .....</b>	<b>133</b>
<b>Annex-12: GRM forPolder40/2 .....</b>	<b>134</b>
<b>Annex-13: Sample Record Keeping Forms .....</b>	<b>138</b>
<b>Annex-14: Emergency Plan .....</b>	<b>144</b>
<b>Annex-15: Layout plan for fuel storage .....</b>	<b>159</b>
<b>Annex-16: Layout plan for construction camp's wastewater management .....</b>	<b>160</b>
<b>Annex-17: Flow diagram for waste management .....</b>	<b>162</b>
<b>Annex-18: Hazard and Incident Reporting and Investigation Procedure.....</b>	<b>166</b>
<b>Annex-19: H&amp;S Plan Draft Set-up.....</b>	<b>190</b>
<b>Annex-20: Construction Traffic Management Plan .....</b>	<b>183</b>
<b>Annex-21: Site Organogram.....</b>	<b>194</b>

## 1 Introduction

### 1.1 The Project

Bangladesh is a low-lying flat delta at the confluence of the Ganges-Brahmaputra-Meghna rivers system. The country is criss-crossed with an intricate network of river sand also has a long coastline in its southern side which is about 710 km long and runs parallel to the Bay of Bengal through 19 districts and 151 Upazilas. The coastal region occupies 20% area of the country. The coastal region is highly susceptible to various natural calamities viz. tidal floods, storm surge, river floods, salinity intrusion which makes livelihoods vulnerable. In order to mitigate the suffering of the inhabitants to some extent the GoB with the assistance of donors has built 139 polders in the coastal region since 60s.

The polders in this area are enclosed on all sides by dykes or embankments, separating the land from the main river system and offering protection against tidal floods, salinity intrusion and sedimentation. The polders were designed to keep the land safe from regular tides and to allow agriculture activities. These polders were equipped with flap gates to control the water inside the embanked area. The polders have been dilapidated due to erosion and lack of proper maintenance. In addition to breaching of the embankments due to cyclones and river erosion, siltation of peripheral rivers surrounding the embankment caused coastal polders to suffer from water logging, which lead to large scale environmental and social degradation and economic losses. Besides, the climate change impact has prompted Sea Level Rise (SLR) and height of the storm surges. Recent cyclones caused substantial damage to the embankments and threatened the integrity of the coastal polders. These polders are required to be rehabilitated for proper functioning towards saving the residents of the localities from the disaster and ensure agricultural and other livelihood activities.

With this end in view, the Government of Bangladesh (GoB) has planned to implement the Coastal Embankment Improvement Project, Phase-1 (CEIP-1), under which seventeen polders will be rehabilitated and improved in the coastal area of the country.

The main objective of the Project is to increase the resilience of coastal population from natural disasters and climate change. Specifically, the Project aims at (a) reducing the loss of assets, crops and livestock during natural disasters; (b) reducing the time of recovery after natural disasters such as cyclones; (c) improving agricultural production by reducing saline water intrusion which is expected to worsen due to climate change; and (d) improving GoB's capacity to respond promptly and effectively to an eligible crisis or emergency.

Polders 32, 33, 35/1 and 35/3 are included in Package one. Polders 43/2C, 47/2, 48, 40/2, 41/1 and 39/2C are included in Package two and polders 14/1, 15, 16, 17/1, 17/2, 23 and 34/3 are included in Package three. In accordance with the national regulatory requirements and WB safeguard policies, EIA studies have been carried out for all polders.

The EIA and the connecting EMP relevant for Polder-40/2 of Package-two of Coastal Embankment Improvement Project, Phase-I (CEIP-I) have been prepared by CEGIS as a sub-

consultant of DDCCS&PMSC. The EMP has been translated in this Contractor's Environmental and Social Management Plan (C-ESMP) for site operational use and purposes. The FIDIC-inspired Contract (CEIP-1)/W-02 is complete as to the Environmental, Health, Safety (EHS) compliances which are fully compatible to the IFC/EHS Guidelines, as outlined in the following WB/IFC website:

<http://www.ifc.org/wps/wcm/connect/554e8d80488658e4b76af76a6515bb18/Final%2B-%2BGeneral%2BEHS%2BGuidelines.pdf?MOD=AJPERES>

## 1.2 Project Activities

The interventions of POLDER-40/2 include the following rehabilitation and improvement activities:

**Table 1-1: Project activities for rehabilitation and improvement for polder no 40/2**

Type of Work	Specification
Re-sectioning of embankment	34.4km
Construction of new embankment	415 m
Construction(Replacement)of Drainage Sluice	9 nos.
Repair of Drainage Sluice	2 nos.
Demolishing of Drainage Sluice	1 no.
Construction(Replacement)of Flushing Sluice	12 nos.
Repair of Flushing Sluice	5 nos.
Demolishing of Flushing Sluice	6 nos.
New construction of Flushing Sluice	1 no.
Re-excavation of Drainage khal	33.6km
Embankment slope protection	1.137 km
Flood Wall	7.9km
Afforestation	17.06 ha

## 1.3 Purpose of the Contractor's Environmental and Social Management Plan

The C-ESMP is to guide progress toward reducing the negative environmental and social impacts and enhancing the positive impacts of projects activities. The C-ESMP establishes a commitment and procedures to measure and decrease the negative environmental & social impacts in key areas, including consumables, indoor & outdoor environmental quality, energy use, water use, transportation, renovations, greenhouse gas emissions, tree cutting, etc. This C-ESMP has been drafted for Polder No. 40/2. For a complete overview of the environmental and social issues applicable for this polder reference is made to the EIA for Polder No. 40/2. The specific Works to be executed in Polder 40/2 including their chainage are shown on the map in Annex 1 (OverviewWorksPolder40/2).

This C-ESMP has been prepared for each activity of the proposed rehabilitation and upgradation works. A site/chainage specific action plan and corresponding checklist shall be prepared before commencement of the physical work of each activity when the specifics of such site are known and can be interpreted. Hence, this document should be seen as a 'living document' subject to changes over time. Moreover, during the execution of

the Works, based on monitoring results or changes in working conditions or aspects of the Works, the necessary mitigation measures and monitoring activities could be altered as well. Therefore, this document is subject to review as and when required.

#### 1.4 Scope of the Contractor's Environmental and Social Management Plan

The C-ESMP objectives include:

- Identify, measure, and manage the potential negative effects of project activities;
- Target specific areas of improvement, with higher priority placed on areas where significant impact is possible.

Provide information to the Engineer to support the application of these principles to our work and internal practices. Particular areas for action are the avoidance of pollution of any land or water (coastal, transitional, surface or groundwater), the preservation of flora and fauna and the avoidance of disruption from noise, vibrations or dust and compliance to Occupational Health and Safety and Public Health and Safety during the course of the works. We (Contractor) are aware of and will be compliant with the recommendations of the Department of Environment (DoE), Bangladesh and the Environmental Safeguard Policies of World Bank. Moreover, with this C-ESMP we intend to comply with the following contract clauses:

General Conditions		Specifications	
4.8	Safety Procedures	1.07	Disruption of Local Communities
4.9	Quality Assurance	1.16	Safety Measures and public convenience
4.14	Avoiding Interference	1.18	Signboards
4.15	Access routes	1.20	Contractor's Offices, Workshops, Accommodations, Inspection shed, etc.
4.18	Protection of the Environment	1.21	Quality Assurance Plan
4.21	Progress reports	1.22	Sanitation
4.22	Security onsite	1.23	Medical Arrangements and First Aid Facilities
6.6	Facilities for Staff and Labor	1.24	Construction and Maintenance of Temporary Access Road
6.7	Health and Safety	1.25	Environmental Mitigation Works
6.13	Supply of Foodstuff	1.30	Contractor's Sites Facilities
6.14	Supply of water		
6.18	Festivals and religious customs		
7.2	Samples		



## 2 Environmental and Social Actions as per Project Component

This section identifies the impacts of the project interventions on environment which may potentially be caused in various Project phases, and also suggests the probable mitigation measures to avoid, offset, reduce, or compensate these impacts. Proposed interventions which may cause potential environmental impacts during pre-construction, construction, and post-construction phases have been identified in Section 2. Accordingly the advice of the World Bank Senior Environmental Specialist the CICO authority has revisited the **Environmental Impacts and Mitigation Measures (Chapter 6) of EIAs for the package 2** and tried to be incorporated all the required mitigation measures herewith minutely. It must be noted that, these sections should be read in conjunction with Section 3 in which the generic Environmental Actions as per environmental or social aspect are described. Different Annexure: Annex. 3-10 also produced to be checked/verified the proposed mitigation measures during implementing the project activities:

### 2.1 Temporary Facilities

Site offices, Regional office, workers' camps and Field Laboratory, etc. will be established by the Contractor at different locations (land to be provided by the Employer) within the project area. We are responsible for preparing the detailed designs and drawings of such facilities and renovation of others after getting prior approval of the Engineer. The following temporary facilities are distinguished:

#### 2.1.1 Site office / Workers' Camp/ Regional office

The impacts from construction and operation of different temporary facilities would not be always the same. As this is a living document, as stated before, those variations will be accommodated in the following reviews of this document when specifics of these facilities and surroundings become available. We shall specify the site specific needs when the actual site is selected and before starting work in that site. Site specific action plans will be elaborated by then as well.

##### 2.1.1.1 Objective

To implement the project in an environment and social friendly situation some temporary facilities should be provided by contractor for its employees and also for the supervising staffs & Engineers of the employer [See Annex-11: Lay out plan for Construction Camp].

##### 2.1.1.2 Current Action

- For the location of construction camps, access roads, etc., a suitable area away from local habitation, ecological sensitive sites, cultural heritage sites and avoid filling the natural water bodies in cooperation with the local authorities will be selected.

- The required area to be taken will be kept minimum and compatible with operational safety and environmental requirements as outlined in the concerned EIA.
- Drainage channels with slopes less than 5% and ditches in camp areas will be installed.
- Nearby drainage works, like ditches, perimeter canals and storm water treatment systems, etc., will be surveyed regularly to prevent them from clogging by debris.
- Road marking to be done for easily incoming and outgoing vehicles.
- Information boards containing the project name, duration, component of works, cost of the work, etc., as per contract. Information will be in English and Bangla. These boards will be erected at one or two prime locations of the polder before starting the temporary works.
- Signboards of a size of not less than 2m by 3m will be erected at each work site. The signboard shall be erected at a suitable place prior to the commencement of the work and to be maintained in good condition during the whole contract period. All information on the Signboard will be written in English and Bangla. Each Signboard shall show the following: i) the name of the Project (including Loan Number), ii) the name of the Employer, iii) all other details of the Contract or as directed by the Engineer.
- Operational areas will have a perimeter fence to have better control and avoid the entry of outsiders.
- Corresponding signalling information will be showed in the camp area (informative, restrictive and preventive) aiming to perform the camp activities in safe and environmental friendly manner.
- Administrative permission from the local authorities (if required) to be taken before starting the physical work.
- Hygiene toilet facilities for men and women workers and provision for safe drinking water will be assured.
- Water conservation and recycling of water; Consideration of use of rainwater where feasible; Avoiding contamination of fresh water sources.
- The collection of wastewater and solid wastes in the area will be carried out properly. Waste water will be collected in a temporary pit for sedimentation before disposing off to a local drainage canal/stream. Solid waste generated from the activities should be minimized. Solid waste will be sorted in separate bins on camp site. Disposables will be collected by covered dump truck/cart and will be sent to the local landfill exists in and around polder areas. In case of absence of landfill or such facilities they will be dumped in an earthen pit and will be covered by soil. Such disposal facility would be approved by the Engineer and will be located away from populated area to prevent odor problem. Recyclable wastes will be sent to local recycle shops.

### **2.1.2 Fuel supplies for cooking and heating purposes**

### **2.1.2.1 Objective**

- Discouraging work force to use fuel wood or other biomass for cooking or heating purposes.

### **2.1.2.2 Current action**

- Sufficient numbers of gas cylinder for domestic cooking for the project personnel will be ensured.
- Gas cylinder to be stored in safe places.

## **2.1.3 By-pass Road Construction**

### **2.1.3.1 Objective**

- The existing embankment is now intensively being used as embankment-cum-road. Re-sectioning works will temporarily make the embankment unavailable for public use. In order to enable undisturbed transport of people and construction materials and to facilitate the execution of the works, by-pass roads might be needed.

### **2.1.3.2 Current action**

- Where needed a by-pass route shall be constructed for use during working hours and arrangements shall be made to circulate this information amongst the local people. Nearby bazaar, school and mosque (within 1 km of the work area) will be informed; they will be requested to use their mikes to inform the people of those facilities. If needed, temporary earthen footpath shall be constructed along the work zone.
- The Cofferdam for Drainage Sluice/Flushing Sluice construction will be used as temporary (by-pass) road for both public and construction activities.
- The by-pass roads shall be properly marked and cautionary/informative signals to be provided along these roads.
- Signal man with safety vest and signalling tools will be deployed during working time especially in the case of embankment construction.
- The measures to control soil erosion will be carried out as necessary, e.g by the water courses, agricultural lands or fish ponds etc.
- Unnecessary vegetation clearance will be avoided. When the vegetation clearance is required, the necessary permits will be obtained.

## **2.1.4 Sanitation**

### **2.1.4.1 Objective**

- Providing hygienic sanitation facilities for the workforce.
- Keeping work force operable and efficient during the project execution period.

### **2.1.4.2 Current action**

- A separate latrine and bathroom shall be provided for each 30 numbers of workers at site.
- Separate latrines and bathing facilities will be reserved for female workers.

- The location of the latrine will be at least 50m away from the accommodation area in labor camps.
- At least 15 m distance will be maintained between latrine and nearby water source.
- Treatment facilities (i.e., septic tank, soak pits, etc.) will be installed for sewerage of toilet and camp site wastes.
- Wastewater from washrooms, kitchens, etc., will be disposed via the camp area's drainage system.
- Toilet blocks will be properly cleaned and disinfected on a daily basis.

## **2.1.5 Water Supply**

### **2.1.5.1 Objective**

- Providing potable water to the persons engaged in the construction.

### **2.1.5.2 Current action**

- The construction camps will be provided with potable water either through installing tube wells (hand pump, shallow and deep tube well), Pond Sand Filter or supplying safe bottled water.
- The location plan of tube wells will take into account that these are not sited near any sanitation facilities as to avoid water contamination.
- The distance of a tube well / surface water resource from a soak pit / toilet will be at least 15m.
- Drainage from the tube well will be diverted into the drainage system of the camp area.
- Separate tube wells are kept reserved for the use by women.
- Safe bottled water will be supplied to the work force in case of disruption of the supply system on emergency basis.
- Half yearly drinking water quality monitoring will be carried out.

## **2.1.6 Temporary Facilities Decommissioning**

### **2.1.6.1 Objective**

- To make the project ready to use and to start providing benefits to the beneficiaries.

### **2.1.6.2 Current action**

- During decommissioning of the camps, all natural areas will be reinstated, for which stripping material removed and stored prior to the construction of camp will be used.
- The camp area, roads, etc., will be recovered by dismantling, if not needed for other purposes; to be decided upon in consultation with local authorities and Engineer.
- The intervened structures (roads, services, etc.) that have been damaged during activities will be reconstructed as per guidance of the concerned authorities.
- Grease and oily matters will be stored in containers and to be handed over to appropriate waste collector for recycling or other purpose.

- Waste chemicals (paint rests, admixtures, and oily rags) will be collected and stored in closed containers and will be neutralized for pH using acid or alkali (i.e. lime, etc.). Those chemicals will be disposed to the solid waste disposal facility after mixing it with cement (5% cement w/w ratio).
- In case of soil contamination by mineral oil, it will be removed and will be transported and buried in confined waste disposal area.
- Soak pits, septic tanks will be covered and effectively sealed off by soil.
- Debris (solid rejected material) will be disposed suitably.
- Underground water tank in a barren/non-agricultural land will be covered with soil. In case of being in an agricultural land, the tank will be removed.
- Checks will be carried out that the areas used by the camp and associated facilities are fully restored at the end of the work.

## 2.2 Construction Works

Works in Polder No. 40/2 comprises the construction and re-sectioning of embankments, construction of retired embankments, construction of flood walls, construction of closures, construction of sluices and inlets, bank and slope protection works, afforestation, and the re-excavation of drainage channels.

### 2.2.1 Construction and re-sectioning of embankments

#### 2.2.1.1 Objective

- Protecting the project area from flood and intrusion of saline water.

#### 2.2.1.2 Current action:

- Pavement (if present) will be removed and disposed of at the premises of BWDB.
- Top soil from areas of earth works will not be used for construction works. The top soil (from surface to 15 cm depth) will be removed and preserved for later use by replacing after completion of works.
- Disposal of excess soil will be done at site with no objection from DoE and local authority.
- All works will be demarcated clearly and properly.
- Signals will be installed to indicate the entry and exits of vehicles and movement of construction equipment in the work area.
- Borrow material (earth) will preferably be collected from outside the polder areas in order to protect the fertile agricultural land (country side) and control of river erosion (river side).
- Borrow materials will only be used when free of pollutants. Samples from borrow materials will be tested for As, Pb, Hg, Cr, and pesticides.
- Earth will not be borrowed from close to the toe line on any part of the embankment.
- Borrowing will be avoided from the following areas:
  - Lands close to toe line and within 50m from toe line.

- Irrigated agricultural lands (In case of necessity for borrowing from such lands, the topsoil shall be preserved in stockpiles, although burrowing of agricultural land is seen as the last resort).
- Grazing land.
- Lands within 1 km of dense settlements.
- Environmentally sensitive areas such as reserve forests, protected forests, and, sanctuary. A distance of at least 500 m will be maintained from such areas.
- Water-bodies (only if permitted by the local authority and with specific pre-approved re-development plans by the concerned authority and engineer- in-charge).
- Streams and seepage areas.
- Areas supporting rare plant/ animal species.
- Following data will be documented for each identified borrowing area before commencing the borrowing activity that provides the basis of the re- development plan:
  - Chainage along with offset distance.
  - Area (sqm).
  - Photograph and plan of the borrowing area from all sides.
  - Type of access/width/surface from the roadway.
  - Soil type, Slope/drainage characteristics.
  - Soil/borrow material test results to check for any contamination
  - Existing land use, for example barren / agricultural /grazing land.
  - Location/name/population of the nearest settlement from borrow area.
  - Quantity excavated (likely and actual) and its use.
  - Copy of agreement with owner/government.
  - Community facility in the vicinity of borrow pit; and
  - Rehabilitation certificate from the land owner along with at least four photographs of the rehabilitated site from different angles.
- To minimize adverse impacts during excavation and transport of material the following measures will be undertaken:
  - At the stockpiling locations, barriers will be constructed to prevent the removal of excavated material due to runoff.
  - During transportation of the material, measures will be taken to minimize the generation of dust and to prevent accidents.
- EHS manager to check site plan and equipment used at each construction site prior to start of civil works and review if necessary EHS tools are provided and if any special attention/ mitigations required. e.g. noise monitoring at community.
- Oil & Chemicals – provide secondary containment and spill kits where oils/chemicals are used. Oil & chemical storage areas should be established at a work site. Display signs.
- Noise- (1) monitor noise level at settlements when they are close to construction site and (2) provide noise barrier if necessary.

- Traffic management at construction site where any works outside the demarcated areas are involved. E.g. temporary closure of a part of road, deployment of guard etc.
- Wastes generated from construction activities will be segregated and reused/recycled when possible. The remaining wastes will be treated and disposed following the local regulations.
- To reduce dust and air pollution, regular watering at the construction sites will be conducted. The appropriate cover will be provided on the construction materials stored at sites and on the trucks to be transported. In addition, Inspection and maintenance of construction vehicles will be regularly carried out.
- Traffic management at construction site where any works outside the demarcated areas are involved. E.g. temporary closure of a part of road, deployment of guard etc.
- Vegetation/tree clearance will be carried out only when the necessary permits are obtained.
- The sufficient EHS precautionary signage should be provided.

## **2.2.2 Demolishing and Construction of drainage sluices, flushing sluices, inlets and flood walls**

### **2.2.2.1 Objective**

- To enhance the irrigation and drainage facilities of the polder area.

### **2.2.2.2 Current action**

- Debris from demolishing of sluices and inlets will be disposed of at a site approved by the Engineer.
- Before starting the construction activities of drainage sluices, ring bundh and diversion channel will be constructed and a dewatering system (ensuring that dewatering operations do not result water turbidity > 30 NTU entering natural waterways) will be installed in order to work in dry conditions.
- Disposal of excess soil will be done with no objection from DoE and local authority.
- No waste water from concrete mixing will be disposed directly to the surface water. Necessary pollution control measures such as treatment at settling ponds should be carried out.
- Steel sheet pile driving will not be done at night.
- The work area will be demarcated clearly.
- Signals will be installed for entry and exit of vehicles and movement of construction equipment in the working area.
- All the temporary and permanent drainage structures under construction will be made free from debris prior to every monsoon.
- EHS manager to check site plan and equipment used at each construction site prior to start of civil works and review if necessary EHS tools are provided and if any special attention/ mitigations required. e.g. noise monitoring at community.

- Oil & Chemicals – provide secondary containment and spill kits where oils/chemicals are used. Oil & chemical storage areas should be established at a work site. Display signs.
- Noise- (1) monitor noise level at settlements when they are close to construction site and (2) provide noise barrier if necessary.
- Traffic management at construction site where any works outside the demarcated areas are involved. E.g. temporary closure of a part of road, deployment of guard etc.
- Wastes generated from construction activities will be segregated and reused/recycled when possible. The remaining wastes will be treated and disposed following the local regulations.
- To reduce dust and air pollution, regular watering at the construction sites will be conducted. The appropriate cover will be provided on the construction materials stored at sites and on the trucks to be transported. In addition, Inspection and maintenance of construction vehicles will be regularly carried out.
- Traffic management at construction site where any works outside the demarcated areas are involved. E.g. temporary closure of a part of road, deployment of guard etc.
- Vegetation/tree clearance will be carried out only when the necessary permits are obtained.
- The sufficient EHS precautionary signage should be provided.
- Avoiding the areas supporting rare plant/ animal species.

**2.2.3 The bank and slope protection works. Mitigation measures for barge are addressed for 4 Polders except Polders 40/2 & 48. Bank protection work is not included in Polders 40/2 & 48.**

**2.2.3.1 Objective**

- Erosion protection of adjacent structures and embankment.

**2.2.3.2 Current action:**

- Spilling of earth material in surface water will be avoided.
- Turfing will be applied to prevent erosion.
- Proper erosion control provisions will be kept to avoid formation of rain cuts due to surface run off.
- EHS manager to check site plan and equipment used at each construction site prior to start of civil works and review if necessary EHS tools are provided and if any special attention/ mitigations required. e.g. noise monitoring at community.
- The sufficient EHS precautionary signage should be provided.
- Avoiding the areas supporting rare plant/ animal species.



## **2.2.4 Re-excavation of drainage channels**

### **2.2.4.1 Objective**

- Improve drainage facility.

### **2.2.4.2 Current action:**

- Unnecessary re-suspension will be avoided by selection of suitable dredging equipment.
- Re-excavated material may be used as embankment material (if necessary, uncontaminated and applicable) or will be placed at suitable places, subject to approval of the Engineer and quality test of soil sample.
- Temporarily deposition of dredged material will be away from the channel edge to limit damage to streamside and stream habitats.
- Return water will be conveyed through siltation chambers to avoid high loads of fines to be discharged on surface water.
- Where applicable biotechnical engineering, for example geo textiles, may be used to help stabilize the material.
- Smothering of important flora and habitats will be avoided.
- EHS manager to check site plan and equipment used at each construction site prior to start of civil works and review if necessary EHS tools are provided and if any special attention/ mitigations required. e.g. noise monitoring at community.
- The sufficient EHS precautionary signage should be provided.
- Avoiding the areas supporting rare plant/ animal species.

## **2.2.5 Manufacture of pre-cast CC blocks**

The comprehensive mitigation measures for CC block plants are addressed herewith as per proposed measures in EHS risk assessment. Actually CC block manufactured in this polder by using Concrete mixture machine. Automatic CC blocks machines are being used only in Polder 39/2C.

### **2.2.5.1 Objective**

- Provide material for sustainable river bank/slope protective work.

### **2.2.5.2 Current action**

- Workers will be equipped with proper PPE.
- First aid box will be available and signposted at site.
- Signals will be installed to indicate the entry and exits and movement of vehicles in the work area.
- A flagman should be appointed to regulate movement of vehicles and other plant & machineries.
- Speed limit sign boards for the vehicles to be erected at certain important locations in plant area
- Proper track/pathway signalling is to be ensured for reducing the risk of accidents.

- Manufacturing only can take place at day time only under proper environmental and social protective conditions.
- Stacks with sand will be covered or wetted to prevent dust forming. Cover haul vehicles carrying dusty materials (cement, sand, etc.).
- Crushing of rocky and aggregate materials will be wet-crushed, or performed with particle emission control system.
- Forklift Operation Safety manual will be ensured in the site
- Water spraying will be ensured in the yard and its surrounded areas to control dusts.
- The sufficient EHS precautionary signage should be provided.
- Avoiding the areas supporting rare plant/ animal species.

### 2.2.5.3 *EHS management plan(s) for CC block mixture machine*

#### **Dust Control:**

- The key raw material for CC Block manufacturing is stone chips, sand and cement. During operation of the plant lot of dust is generated from the plant which needs to be controlled. Dust suppression measures like use of sprinklers on the ingredients and wetting the roads, using dust control barriers around the plant, use of masks by the workers/visitors whom will be engaged in the plants shall be confirmed by the onsite EHS manager from CICO. The frequency of use of sprinklers will be as and when required.

#### **Gaseous Emission:**

- There is no CC block manufacturing plant in this polder. So, there is no scope of Gaseous emission from the CC block manufacturing plant may introduce risk to the local communities and workers. A few gaseous emissions may take place from mixture machine which will be controlled by proper maintenance of the machine and extending the exhaust outlet in proper height.

#### **Air Emissions**

The following activities will be adhered to:

- Fit vehicles with appropriate exhaust systems and emission control devices. Maintain these devices in good working condition.
- Service all vehicles regularly in accordance with manufactures maintenance procedures to minimize emissions.
- Operate the vehicles in a fuel efficient manner.
- Cover haul vehicles carrying dusty materials (cement, borrow, etc.) moving between outside and the construction site or water construction material if suitable.
- Impose speed limits on all vehicle movement at the worksite to reduce dust emissions.
- Control the movement of construction traffic.
- Cover the construction materials to check erosion and dust/air and other

pollution.

- Watering the material stockpiles, access roads and bare soils as and when required to minimize dust emissions.
- Increase the watering frequency during periods of high risk (e.g., high winds, hot & dry weather).
- Minimize the extent and period of exposure of the bare surfaces.
- Reschedule earthwork activities or vegetation clearing activities, where practical, if necessary to avoid during periods of high wind and if visible dust is blowing off-site
- Restore disturbed areas/side of the embankment as soon as practicable by plantation/vegetation/grass-turfing.
- Establish adequate locations for storage, mixing and loading of construction materials, in a way that dust dispersion is prevented because of such operations.
- Performance of monitoring.
- The sufficient EHS precautionary signage should be provided.

### **Noise Control**

- Noise generated from the plants may become a problem for workers within the camp areas and also for nearby inhabitants. Appropriate noise barrier and silencer to be used for control the noise from the CC block casting plant
- Ear plugs and other PPEs to be ensured for the workers by the on-site EHS manager from CICO.
- Construction Vehicular Traffic
  - Maintenance of all vehicles in order to keep them in good working order in accordance with manufacturer's maintenance procedures.
  - Organizing the loading and unloading of trucks, and handling operations for the purpose of minimizing construction noise at the work site.
- Construction Machinery
  - Appropriately site all noise generating activities to avoid noise pollution to local residents
  - Maintain all equipment in order to keep it in good working order in accordance with manufactures maintenance procedures.
- Construction Activity
  - Location of all noise generating activities to be avoided that will cause noise pollution to local residents.

- Adjacent landholders, educational institution etc. will be notified prior to any typical noise events.
- Temporary noise control barriers will be installed where appropriate.
- Activities on site and deliveries to and from site will be organized such as to minimize impact.
- Working during 09:00pm to 06:00 am will be avoided within 500m from the existing residences.
- Monitor and analyse noise and vibration results and adjust construction practices as required.

Regular i.e. twice in a month (at each two weeks) sound level will be measured to monitor/check compliance at CC block manufacturing area and nearby communities of CC block yard and structural works of drainage as well as flushing sluice . Automatic CC blocks machines are using only in Polder 39/2C, where the contractor is advised for conducting half yearly hearing tests for CC block machine operators/other workers deployed in machine area. The hearing test (once in six months) for automatic CC plant operators will be conducted.

#### **Transportation:**

- Risk is involved with the transportation of the ingredients of the CC blocks and the CC blocks. Proper traffic management plan is prepared and shall be enforced at site so that no incidents occur during transportation and stacking of CC blocks.
- Measures include; having speed limits (15km) on site, install signboards, separation of pedestrians and forklift trucks, and toolbox talks.
- The sufficient EHS precautionary signage should be provided.
- Avoiding the areas supporting rare plant/ animal species.

#### **Water Disposal:**

- Water disposed from the plants shall not be allowed to discharge to the open channel directly. It shall pass through a sedimentation tank so that it could not cause any harm to the nearby water bodies.

#### **Stacking of CC Blocks**

- Stacking of CC blocks shall be done following the specification of BWDB. Solid platform shall be prepared before commencement of CC block stacking within the plant area. Height of stack to be controlled so that it does not exceeds 1.50m from the ground.
- CC block stacks shall be properly labelled with date of production, and CC size.
- The sufficient EHS precautionary signage should be provided.

- Avoiding the areas supporting rare plant/ animal species.

## 2.2.6 Chemicals and Fuel Storage Areas

### 2.2.6.1 Objective

- Safely storing of chemicals and fuel in sufficient volumes for use in construction plants and machineries.

### 2.2.6.2 Current action

- Use of chemicals and fuel use are reduced as much as possible. All chemicals and fuel stored on site will be confined to specific, secured, and bounded areas with an impervious surface. Fuel storage areas will have an adequate secondary storage capacity (at least 110 percent of the largest storage container, or 25 percent of the total storage capacity (whichever is greater), in that specific location).
- Chemicals and Fuel storage areas will have an adequate protection from the rain. Temporary tin shed to be erected on each fuel tank to protect it from rain and sun.
- The physical condition of the tanks and the inlet and outlet of the fuel will be checked on a regular basis (weekly) to prevent spillage and leakage.
- Drainage of rain water in the fuel storage area shall be .
- Chemicals and Fuel storage areas will be clearly marked (in English, Bangla and Chinese) indicating the dangers of explosion.
- Points will be marked with the location of fire extinguishers. Sufficient numbers of fire extinguisher to be kept reserved under shed with expiry date for use in the fuel zone.
- Sand and shovel will be kept available nearby the fuel storage area.
- Permits from the authority for storage of fuels will be obtained.
- Fencing with barbed wire with proper cautionary signals will be installed.
- The Material Safety Data Sheet (MSDS) from supplier of hazardous substances (diesel, oil, lubricant) will be collected and placed besides containers/storage.
- Spill kit/absorbent mat will be in place to catch any spilled fuels at the location where potential spillage may occur.
- The sufficient EHS precautionary signage should be provided.
- Avoiding the areas supporting rare plant/ animal species.
- Avoiding the areas supporting rare plant/ animal species.

## 2.3 Waste

### 2.3.1 Non-hazardous Solid Waste

The following measures for the handling and management of non-hazardous solid waste will be implemented:

- Installing containers/bins to store non-hazardous solid waste. Containers must have sufficient capacity for the frequency of collection established at the work sites.

- Containers used for storage of waste should be provided with lids that prevent rainwater from entering the trash and overflow them. This will also prevent the sun to accelerate waste decomposition, generate odours or help the proliferation of flies, or spilled/scattered by the scavengers like stray dogs, crows.
- The term collection includes not only the collection of solid wastes from the various sources, but also the hauling of these wastes to the location where the contents of the collection vehicles are emptied.
- Waste produced will be collected for disposal at an appropriate waste dump site.
- No burning of solid waste out on the open or in the containers will be done.
- The sufficient EHS precautionary signage should be provided.
- Avoiding the areas supporting rare plant/ animal species.

### **2.3.2 Hazardous Waste**

The following measures for the handling and management of hazardous solid waste will be implemented:

- Stored in properly labelled containers for easy identification
- Separated from low lying, flood-prone areas.
- Secondary spill and leak containment will be installed.
- Extra fire hydrants will be provided near the storage area.
- Explosion-suppressing electrical fixtures and wiring will be used for electrical purpose if needed.
- Adequate number of fire extinguishers, including foam fire extinguishers will be ensured.
- Explosion blow-out (pressure relief) panels will be provided in storage room.
- Will be located on an impervious surface.
- Will be protected from the rain and direct sunlight.
- Disposal in an appropriate way as soon as possible.
- Encourage proper treatment to recycle/reuse of waste.
- The sufficient EHS precautionary signage should be provided.
- Avoiding the areas supporting rare plant/ animal species.

### **2.4 Waste water**

The following activities will be adhered to waste water at construction sites:

- Installation of decanter boxes for washing buckets and balloon mixers
- Installation of proper filtering elements.
- Carrying out periodic checks and clean-ups for the decanter box.

- 
- Prioritize reuse of aggregates and water from the decanter box.

## 2.5 Occupational Health and Safety

A Health and Safety Plan has been developed and will be implemented that will include, but not be limited to:

- National and World Bank Occupational Health and Safety Standards in force and applicable to project activities.
- Environmental and security policies of the company.
- Worker responsibilities regarding the use and care of clothing and other personal protective equipment.
- Emergency procedures.
- Specific job hazards.
- Safety precautions.
- Job responsibilities.
- Training programme for all construction workers in basic sanitation and health care issues and safety matters and on the specific hazards of their work.
- Provision of HIV testing, including STI (sexually transmitted infections) information, education and communication.
- The sufficient EHS precautionary signage should be provided.

The following services will be enabled at the construction sites:

- Fire extinguishers clearly signposted.
- First aid facility clearly signposted.
- Stock of medicines at site.
- Personal Protective Equipment.

## 2.6 Public Health and Safety

- Members of the public adjacent to the construction area will be notified of construction activities in order to limit unnecessary disturbance or interference.
- At all times, safe and convenient passage for vehicles, pedestrians and livestock will be provided.
- All necessary measures for the safety of traffic during construction will be taken, including signs, markings, flags, lights and flagmen as may be required.
- The temporary traffic detours in settlement areas will be kept free of dust by

frequent application of water.

- Construction activities will be undertaken according to during daylight working hours between the hours of 07:00 – 17:00 on weekdays.
- Construction vehicles will avoid public roads during peak hours.
- Special consideration will be given to the safety of pedestrians and workers at night.
- Liaison with the communities will be maintained and Grievances Redress Mechanism to be established immediately

## 2.7 Cultural Properties

- Necessary and adequate care will be taken to minimize impact on cultural properties which includes cultural sites and remains, places of worship including temples, mosques, churches and shrines, etc., graveyards, monuments and any other important structures as identified during design and all properties / sites / remains notified.
- No work will spill over to these properties and premises. If needed, design options for cultural property relocation and enhancement will be prepared.
- All conservation and protection measures will be taken up as per design. Access to such properties from the road will be maintained clear.
- The sufficient EHS precautionary signage should be provided.

## 2.8 Flora and Fauna Management

- Flora
  - Only designated sites allocated for construction works will be used.
  - Tree felling will be performed upon preliminary notification to the relevant authority (Divisional Forest Office, DoE).
  - All trees to be removed should be counted and marked to avoid excessive number of trees to be felled and provision of proper treatment of the remaining trees.
  - Adequate knowledge to the workers regarding natural protection and the need of avoiding felling/damaging trees during construction will be provided.

Trees will not be cut or felled if birds are nesting on the trees.

- Tree cutting and clearing will be avoided around streams, restricted areas e.g., native vegetation, protected riparian strips, historic and heritage sites, research areas.
- For site re-vegetation, local species will be selected as planting materials.
- Proper turfing should be implemented at embankment slopes with local



grasses (i.e. Durba (*Cynodondactylon*), Mutha (*Cyperus* sp) and ensure regular monitoring of turf grasses till they are matured.

- Fruit and timber trees owned by local population will be compensated at their replacement cost according to market prices (Compensation guidelines to be followed).
- Fauna
  - No animals will be disturbed unnecessarily and no animals to be shot, trapped, or caught for any reason whatsoever.
  - Critical breeding areas of major fish species will be identified, left undisturbed, and declared as sanctuaries.
  - Creation of small lagoons and pools that may trap fish will be avoided.
  - Sufficient free flow will be guaranteed in the construction works to ensure free passage of migrating fishes.
  - Endangered animals like dolphins, turtles move in the peripheral rivers. Pinger's will be used to drive away the dolphins prior to initiation of dredging activities in the peripheral rivers.
  - Dredging during spawning periods of commercially important fishes (like hilsa, pangas, sea bass, etc.)will be avoided.
  - Dredging activities will create minimum sediment load in the water.

## 2.9 Soil Management

- Preferably soils from fallow lands / non-agricultural lands will be used in earthworks.
- To minimize the adverse impact during excavation, storage and transport of material the following measures will be undertaken:
  - Adequate drainage system will be provided at the excavated area if applicable.
  - At the stockpiling locations, sediment barriers to prevent the erosion of excavated material due to runoff will be constructed.
  - During transportation of the material, measures will be taken to minimize the generation of dust.
- Top soil will be striped before earth filling and stored for reuse at final surfacing of embankment top and tree plantation/afforestation.
- Top soil will be striped to a depth of 15 cm and store in stock piles of height not exceeding 2m to maintain the physio-chemical and biological activity of the soil.
- Unwanted materials like grass, roots of trees and similar others will be removed from top soil.

- Slopes of stockpiles will not exceed 2:1 to reduce surface runoff and enhance percolation through the mass of stored soil.
- Stockpiles will be located in areas outside drainage lines and will be protect from erosion.
- Topsoil stockpiles will be monitored and should any adverse conditions like erosion be identified, corrective actions will be taken.
- The sufficient EHS precautionary signage should be provided.

### **2.10 Electrical Safety**

- Safety protocols, measures to be notified in a clearly visible place at the work place and other areas where there are electrical appliances/equipment.
- Proper PPEs to be used when using/operating any electrical machine/equipment
- Electrical wires to be checked regularly for proper insulation to prevent any accident or fire due to short circuit.
- Some of the staffs to be trained to handle emergency situation and liaison to be maintained with nearby hospitals for emergencies.
  - The sufficient EHS precautionary signage should be provided.

### **2.11 Labour Influx**

There is no migrant labour influx, local labourers are employed for the construction works. Labours are screened for any contagious diseases prior to their engagement.

### 3 Actions as per Environmental and Social Aspect

#### A. Actions as per Environmental and Social aspects for CC block manufacturing site

##### 3.1 Occupational Health and Safety

A Health and Safety Plan has been developed (**attached as Annexure 19** with this report) and implemented that will include, but not be limited to:

- National and World Bank Occupational Health and Safety Standards in force and applicable to project activities.
- Environmental and health policies of the company.
- Worker responsibilities regarding the use and care of clothing and other personal protective equipment.
- Emergency procedures.
- Specific job hazards.
- Safety precautions.
- Job responsibilities.
- Training program for all construction workers in basic sanitation and health care issues and safety matters and on the specific hazards of their work. A preliminary training program (Table-6.2) is enclosed describing the type and frequency of training.
- All personnel working in the camp areas shall be provided with required personal protective equipment (PPE).
- Tool box meetings shall be arranged for the workers at site in each week by the concerned EHS manager.
- Provision of HIV, including STI (sexually transmitted infections) information, education and communication will be arranged.

The following services will be enabled at the construction sites:

- Fire extinguishers clearly signposted.
- First aid facility clearly signposted.
- Stock of medicines at site.
- Personal Protective Equipment.

##### 3.2 Public Health and Safety

- Members of the public adjacent to the construction areas will be notified of construction activities in order to limit unnecessary disturbance or interference.
- At all times, safe and convenient passage for vehicles, pedestrians and livestock will be provided.
- All necessary measures for the safety of traffic during construction will be taken, including signs, markings, flags, lights and flagmen as may be required.

- The temporary traffic detours in settlement areas will be kept free of dust by frequent application of water.
- Construction activities will be undertaken during daylight working hours between the hours of 07:00 – 17:00 on weekdays.
- Construction vehicles will avoid public roads during peak hours.
- Special consideration will be given to the safety of pedestrians and workers at night.
- Liaison with the communities will be maintained and Grievances Redress Mechanism to be established immediately.
- Proper measures shall be taken by the contractor for prevention of diseases. These measures may include regular health check up by the registered physician at the work site once in a month. Vaccination and other similar programs can be arranged for transmittable diseases.
- Traffic Management Plan is attached in and annex for the said polder.

### 3.3 Cultural Properties

- Necessary and adequate care will be taken to minimize impact on cultural properties which includes cultural sites and remains, places of worship including temples, mosques, churches and shrines, graveyards, monuments and any other important structures as identified during design and all properties / sites/ remains notified.
- No work will spill over to these properties and premises. If needed, design options for cultural property relocation and enhancement will be prepared.
- Access to such properties from the road will be maintained clear.

#### Chance- Find Procedures for Physical Cultural Property

The Contractor will apply the following “Chance Finds Procedures”

- Identify a registered heritage practitioner before the initiation of any construction activities.
- Review relevant documentation (mainly applicable EIA) to get acquainted with the heritage resources in the Polders.
- All construction staff should be properly instructed to ensure the safeguarding of the potential heritage resource.

In case culturally valuable materials are uncovered during excavation or any project activities this chance fine procedure as per Antiquities Act, 1968, will be put in place, including:

- Stop work immediately following the discovery of any materials with possible archaeological, historical, paleontological or other cultural value, for up to 72 hours, to announce findings to project manager and notify relevant authorities.
- Protect artefacts; demarcation fencing to be installed, as well as possible using plastic covers, and implement measures to stabilize the area, if necessary, to properly protect artefacts.
- Prevent and penalize any unauthorized access to the artefacts; and

- Restart construction works only upon the authorization of the relevant authorities (e.g. Upazila Nirbahi Officer, Deputy Commissioner and Department of Archaeology to sign-off the inspected areas).

Chance grave finds if people are buried in the project area.

To ensure that graves that will be affected by the Project are properly dealt with:

- In the event of the identification of graves or burial grounds, or human remains, the relevant authorities should be informed immediately
- Careful attention needs to be paid to the statutory requirements if any grave and or human remains are discovered.
- Graves shall not be disturbed in any way after it is discovered except under the authority of the competent authorities and after the area has been checked for other graves by a representative of the relevant authorities in co-operation with the Bangladesh Police Service.
- The formal procedure shall apply for permit applications to destroy, damage, alter, exhume or remove from its original position or otherwise disturb the grave or any burial ground or part thereof that contains such graves.
- The site manager may only recommend work once full clearance from the relevant authority is obtained.

### **3.4 Solid Waste Management**

#### **3.4.1 Non-hazardous Solid Waste**

The following measures for the handling and management of non-hazardous solid wastes will be implemented:

- Installing containers/bins to store non-hazardous solid waste. Containers will have sufficient capacity for the frequency of collection established in the works. Separate bins will be provided for different types of solid waste (like P.E.T bottles, cans, papers, plastic etc.).
- Containers used for storage of waste will be provided with lid that prevent rain water from entering the trash and overflow them as well as keep the scavengers away. This will also prevent the sun to accelerate waste decomposition, generate odors or help the proliferation of flies.
- Waste produced will be collected for disposal at an appropriate waste dump site as suggested by the local authority.
- No burning of solid waste out in the open or in the containers will be done.
- Recording of waste disposal will be documented regularly.
- Avoiding the areas supporting rare plant/ animal species.

#### **3.4.2 Hazardous Waste**

All hazardous wastes will be:

- Stored in properly labelled containers for easy identification.
- Separated from low lying, flood-prone areas.

- Located on an impervious surface in temporally industrial waste storage area.
- Protected from the rain or sun, as the case may be.
- Treatment and disposal in an appropriate way as soon as possible. Treatment and disposal option will have to be approved by the local / environmental authority.
- Recycle/reuse wastes as much as possible.

### **Fuel/Chemical storage Areas**

- All fuel stored on site will be confined to specific, secured, and bounded areas with an impervious surface. Fuel storage areas will have an adequate secondary storage capacity (at least 110% of the total volume stored in the tanks) and be protected from the direct sun light and rain.
- The physical condition of the tanks and the inlet and outlet of the fuel will be checked to prevent spills by deficiencies in them.
- A control valve will be installed for drainage of rain water in the fuel storage area. The valve will remain padlocked at all times. For drainage of rain water, a grease trap will be incorporated prior to discharge on the storm water channel to control oil discharges into the environment.
- Fuel storage areas will be clearly marked indicating the dangers of explosion.
- Points will be marked with the location of fire extinguishers, sand storage with bucket and shovel at nearby distance of fuel storage area. Fire extinguishers will be placed under the shade, free from rain and direct sunshine and date of expiry will be clearly displayed/visible.
- Fuel storage area will be installed in an elevated place to protect from the tidal effect, especially for automatic CC block manufacturing plant as it will be located close to the river.
- The refuelling area will be impervious, approachable and facilitated with sufficient drainage system to prevent water logging.
- Protection measures in case of any accidental spillage will be ensured.
- All information of fuel storage area will be marked including container capacity, fuel type and dimension of secondary container, name and mobile number of responsible person.
- The Material Safety Data Sheet (MSDS) from supplier of hazardous substances (diesel, oil, lubricant) will be collected and placed besides containers/storage.
- Spill kit/absorbent mat will be in place to catch any spilled fuels at the location where potential spillage may occur. Sufficient hydrants to address potential fire should be equipped at fuel storage area as well as the areas where chemicals/fuels are used.
- The sufficient EHS precautionary signage should be provided.
- Avoiding the areas supporting rare plant/ animal species.

### **3.5 Waste water**

The following activities will be adhered to waste water disposal at construction sites:

- Installation of decanter boxes for washing buckets and balloon mixers.

- Installation of proper filtering elements before discharge on surface water.
- Carrying out periodic checks and clean-ups for the decanter box.
- Prioritize reuse of aggregates and water from the decanter box.
- If required, settling pond with proper drainage channels will be made so that any overflow of water may be retained in the settling pond.
- Unauthorized wastewater discharge is prohibited to outside of the project sites.

### **3.6 Air Emissions**

The following activities will be adhered to:

- Fit vehicles with appropriate exhaust systems and emission control devices.
- Maintain these devices in good working condition.
- Service all vehicles regularly in accordance with manufactures maintenance procedures to minimize emissions.
- Operate the vehicles in a fuel-efficient manner.
- Cover haul vehicles carrying dusty materials (cement, borrow material), or other, construction material, if required.
- Impose speed limits on all vehicle movement at the worksite to reduce dust emissions/ suspension from roadways.
- Control the movement of construction traffic.
- Cover the construction materials to control erosion and dust formation.
- Watering the material stockpiles, access roads and bare soils as and when required to minimize dust emissions.
- Increase the watering frequency during periods of high risk (e.g., high winds).
- Minimize the extent and period of exposure of bare surfaces.
- Reschedule earthwork activities or vegetation clearing activities, where practical, if necessary to avoid periods of high wind and if visible dust is blowing off-site.
- Restore disturbed areas/sides of the embankment as soon as practicable by plantation/vegetation/grass-turfing.
- Establish adequate locations for storage, mixing and loading of construction materials, in a way that dust dispersion is prevented because of such operations.
- Performance of monitoring.

### **3.7 Noise Management**

The following activities will be adhered to:

- Construction Vehicular Traffic
  - Maintenance of all vehicles in order to keep them in good working order in accordance with manufacturer's maintenance procedures.
  - Organizing the loading and unloading of trucks, and handling operations for the purpose of minimizing construction noise at the work site.
- Construction Machinery
  - Appropriately site all noise generating activities to avoid noise pollution to local residents.

- Maintain all equipment in order to keep it in good working order in accordance with manufactures maintenance procedures.
- Construction Activity
  - Location of all noise generating activities to be avoided that will cause noise pollution to local residents.
  - Adjacent landholders, educational institution, etc., will be notified prior to any typical noise events.
  - Temporary noise control barriers will be installed where appropriate.
  - Activities on site and deliveries to and from site will be organized such as to minimize impact.
  - Working during 09:00pm to 06:00 am will be avoided within 500m from the existing residences.
  - Monitor and analyze noise and vibration results and adjust construction practices as required.
  - Hearing tests of the workers engaged in high noise exposure areas will be done half yearly.

### 3.8 Water Management

Measures will be taken in order to prevent pollution, erosion and sedimentation in water courses by:

- Refuelling will not take place within 50m from surface water.
- Installing temporary sediment basins, where appropriate, to capture sediment-laden run-off.
- Preventing all solid and liquid wastes entering waterways by collecting solid waste, oils, lubricants, chemicals, fertilizer waste and transport to an approved waste disposal site.
- All temporary working sites will be reinstated ASAP to its initial conditions (relief, topsoil, vegetation cover).
- Excess water coming from filling up land with riverbed material will be discharged to the river through sediment settling basin.
- Preventing discharge of cement and water used for curing cement/concrete into water courses and drainage inlets. If unavoidable, then discharge water through settling pond.
- Monitoring the water quality in the runoff from the site or areas affected by dredge spoil plumes and improving work practices as necessary.
- Use of plastic sheet or gravel in the workshop and equipment yard to prevent soil and water contamination.

### 3.9 Flora and Fauna Management

- Flora
  - Only designated sites allocated for construction works will be used.



- Tree felling will be performed upon preliminary notification to the relevant authority (Divisional Forest Office and DoE).
- All trees to be removed should be counted and marked to avoid excessive numbers of trees to be felled and provision for proper treatment of the remaining trees.
- Adequate knowledge to the workers regarding nature protection and the need of avoiding felling/damaging trees during construction will be provided.
- Tree cutting and clearing will be avoided around streams, restricted areas, e.g., native vegetation, protected riparian strips, historic and heritage sites, research areas.
- For site re-vegetation, local species will be selected as planting materials.
- Proper close turfing should be implemented at embankment slopes with local grasses i.e., Durba (*Cynodon dactylon*), Mutha (*Cyperus* sp.) and ensure regular monitoring and if needed watering of turf grasses till they mature.
- Fruit and timber trees owned by local population will be compensated at their replacement cost according to market prices (Compensation guidelines to be followed).
- Fauna
  - No animals will be disturbed unnecessarily and no animals will be shot, trapped or caught for any reason.
  - If any critical breeding area is available for major fish species that will be identified and declared as sanctuaries.
  - Creation of small lagoons and pools that may trap fish will be avoided.
  - Sufficient free flow will be guaranteed in the construction works to ensure free passage of migrating fishes.
  - Dredging during fish spawning periods will be avoided.
  - Dredging activities will create minimum sediment load in the water provided appropriate measures are taken.
  - Pingers may be used to keep aquatic animals away particularly dolphins, turtles from the dredging sites.

- **Special measures for Sundarbans and coastal green belt vegetation**

Sundarban is the largest mangrove wetland in the world. It covers an area of about 1mha, of which 60% is located in Bangladesh and the remaining western portion, comprising 40%, lies in India. The Sundarbans is of universal importance for globally endangered species including the Royal Bengal Tiger, Ganges and Irawadi dolphins, estuarine crocodiles and the critically endangered endemic river terrapin (*Batagur baska*). It is the only mangrove habitat in the world for *Panthera tigris tigris* species. The Sundarbans is a cluster of low-lying islands in the Bay of Bengal, spread across India and Bangladesh, famous for its unique mangrove forests. There are about 80 different species of mangrove trees. All of these trees grow in areas with low-oxygen soil, where slow-moving waters allow fine sediments to accumulate. A network of estuaries, tidal rivers, and creeks intersected by numerous channels, it encloses flat,

densely forested, marshy islands. The total area of the Sundarbans, including both land and water, is roughly 3,860 square miles (10,000 square km), about three-fifths of which is in Bangladesh. This active delta region is among the largest in the world, measuring about 40,000 sq km. The Sundarban forest lies in the vast delta on the Bay of Bengal formed by the super confluence of the Ganges, Hooghly, Padma, Brahmaputra and Meghna rivers across southern Bangladesh. The seasonally flooded Sundarbans freshwater swamp forests lie inland from the mangrove forests on the coastal fringe. They are called so because there are many Sundari trees found in that region. It is the largest delta in India formed by Ganga, Bhramputra and Meghna river.

- The region is densely covered by mangrove forests and is the home for Royal Bengal Tiger.
- The Sundarbans Inscribed as UNESCO World Heritage Site.
- The inscription of the Sundarbans in Bangladesh as a UNESCO World Heritage Site on 7 December 1997 is a manifestation of the importance of the area's unique ecosystem.

The Sundarbans are the largest mangrove forest in the world, covering 10,000 square kilometres in India and Bangladesh. The mangrove forest also plays a crucial role as a buffer between the land and sea, its effective conservation is essential to the coastal people's survival. Now a day, it has a fragile ecosystem as freshwater flow into the forest has been drastically reduced, resulting in substantial increases in siltation and salinity that are threatening the overall balance of the ecosystem. So CICO will be always care full for assuring better pertaining of this forest, though our construction sites is not closest to Sundarbans.

- Project relevant personnel/staff and laborers will not enter the Sundarbans, nor will cause any activity (causing loud noise, smoke or flush light; hunt or capture any animals or reptiles) which disrupts normal habitat of the wildlife in Sundarbans.
- Such activity will be considered as a violation of discipline and will be punishable by termination of job as well as by local laws, if and when applicable.
- Project will make sure that the green belt vegetation along the coastline is kept undisturbed and all activities remain outside of that vegetation area.
- Check before the commencement of the works if there are any species with ecological importance or their habitats are identified in and near construction area.
- If any species with ecological importance were identified during the work, construction works will be stopped and seek advice from environmental specialists of PMU and DDCS. When necessary, the guidance should be sought from environmental authority.
- Local EHS officer will be engaged for continuous visual observation of fauna and flora during construction. He will also make liaison with the authority of forest, fisheries and livestock's.

### 3.10 Soil Management

- Preferably soils from fallow lands / non-agricultural lands will be used in earthworks.
- To minimize the adverse impact during excavation, storage and transport of material the following measures will be undertaken:
  - Adequate drainage system will be provided at the excavated area if applicable.
  - At the stockpiling locations, sediment barriers to prevent the erosion of excavated material due to runoff will be constructed.
  - During transportation of the material, measures will be taken to minimize spillage, the generation and dispersion of dust.
- Top soil will be striped before earth filling and stored for reuse at final surfacing of embankment top and tree plantation/afforestation.
- Top soil will be striped to a depth of 15 cm and stored in stock piles of height not exceeding 2m to maintain the physical-chemical and biological activity of the soil.
- Unwanted materials like grass, roots of trees and similar others will be removed from top soil.
- Slopes of stockpiles will not exceed 2:1 to reduce surface runoff and enhance percolation through the mass of stored soil.
- Stockpiles will be located in areas outside drainage lines and will be protected from erosion.

### 3.11 Payment of Wages

- A register showing the name, designation, working period, overtime hours, gross salary shall be maintained in the site areas where wages are to be paid. All workers shall receive the wages from CICO with a sign in the relevant register on the revenue stamps.

### 3.12 Code of conduct

- CICO has code of conduct which is applicable for both of it's the staffs and workers. The code of conduct will ensure that the employees and workers act professionally and reliably when interacting with the general public and with each other. This Code has established a common understanding of the standards on behaviour expected of all employees and workers of CICO.

## B. Actions as per Environmental and Social aspects for other construction site

### 3.13 Construction and re-sectioning of embankments

- Pavement (if present) will be removed and disposed of at the premises of BWDB.
- Top soil from areas of earth works will not be used for construction works. The top soil (from surface to 15 cm depth) will be removed and preserved for later use of replacing after construction and during rehabilitation.

- Disposal of excess soil will be done at site with no objection from DoE and local authority.
- All works will be demarcated clearly.
- Signals will be installed to indicate the entry and exit points of vehicles and movement of construction equipment in the work area.
- Borrow material (earth) will preferably be collected from outside the polder areas in order to protect the fertile agricultural land (country side) and control of river erosion (river side).
- Borrow materials will be tested for any contamination/toxicity and will only be used when free of any toxic or harmful pollutants. If the borrow material is found contaminated it will be properly treated prior to any use.
- Earth will not be borrowed from close to the toe line on any part of the embankment.
- Borrowing will be avoided from the following areas:
  - Lands close to toe line and within 50m from toe line.
  - Irrigated agricultural lands. (In case of necessity for borrowing from such lands, the topsoil shall be preserved in stockpiles, although burrowing of agricultural land is discouraging).
  - Grazing land.
  - Lands within 1 km of settlements.
  - Environmentally sensitive areas such as reserve forests, protected forests, sanctuary and wetlands. A distance of at least 500 m will be maintained from such areas.
  - Water-bodies (only if permitted by the local authority and with specific pre-approved re-development plans by the concerned authority and engineer-in-charge).
  - Streams and seepage areas.
  - Areas supporting rare plant/ animal species.
- Following data will be documented for each identified borrowing area before commencing the borrowing activity that provides the basis of the re-development plan:
  - Chainage along with offset distance.
  - Area (Sq.m).
  - Photograph and plan of the borrowing area from all sides.
  - Type of access/width/surface from the roadway.
  - Soil type, Slope/drainage characteristics.
  - Existing land use, for example barren / agricultural /grazing land.
  - Location/name/population of the nearest settlement from borrow area.

- Quantity excavated (likely and actual) and its use.
- Copy of agreement with owner/government.
- Community facility in the vicinity of borrow pit; and
- Rehabilitation certificate from the land owner along with at least four photographs of the rehabilitated site from different angles.
- To minimize adverse impacts during excavation and transport of material the following measures will be undertaken:
  - At the stockpiling locations barriers will be constructed to prevent the removal of excavated material due to runoff.
  - During transportation of the material, measures will be taken to minimize the generation of dust and to prevent accidents.
- EHS manager to check site plan and equipment used at each construction site prior to start of civil works and review if necessary EHS tools are provided and if any special attention/ mitigations required. e.g. noise monitoring at community.
- Oil & Chemicals – provide secondary containment, bund, ditch and spill kits where oils/chemicals are used. Oil & chemical storage areas should be established at a work site. Display signs.
- Noise- (1) monitor noise level at settlements when they are close to construction site and (2) provide quality ear plug/muff to workers, noise barrier if necessary.
- Traffic management at construction site where any works outside the demarcated areas are involved. E.g. temporary closure of a part of road, deployment of guard etc.
- Wastes generated from construction activities will be segregated and reused/recycled when possible. The remaining wastes will be treated and disposed following the local regulations.
- To reduce dust and air pollution, regular watering at the construction sites will be conducted. The appropriate cover will be provided on the construction materials stored at sites and on the trucks to be transported. In addition, Inspection and maintenance of construction vehicles will be regularly carried out.
- Vegetation/tree clearance will be carried out only when the necessary permits are obtained.
- Sufficient EHS precautionary signage should be provided.

### **3.14 Demolishing and Construction of drainage sluices, flushing sluices and inlets**

- Demolishing debris of sluices and inlets will be disposed of at a site approved by the Engineer.
- Before starting the construction activities of drainage sluices, ring bundh and diversion channel will be constructed and a dewatering system (ensuring that dewatering operations do not result water turbidity > 30 NTU entering natural

---

waterways) will be installed in order to work in dry conditions.

- Disposal of excess soil will be done with no objection from DoE and local authority.
- No waste water from concrete mixing will be disposed of directly to the surface water.
- Steel sheet pile driving will not be done at night.
- The work area will be demarcated clearly.
- Signals will be installed to indicate the entry and exits of vehicles and movement of construction equipment in the work area.
- Prior to every monsoon season all the temporary and permanent drainage structures under construction will be made free from debris.
- EHS manager to check site plan and equipment used at each construction site prior to start of civil works and review if necessary EHS tools are provided and if any special attention/ mitigations required. e.g. noise monitoring at community and adoption of proper measure, if necessary
- Noise- (1) monitor noise level at settlements when they are close to construction site and (2) provide noise barrier if necessary.
- Traffic management at construction site where any works outside the demarcated areas are involved. e.g. temporary closure of a part of road, deployment of guard, etc.
- Wastes generated from construction activities will be segregated and reused/recycled when possible. The remaining wastes will be treated and disposed following the local regulations. Special care will be taken for the hazardous waste.
- To reduce dust and air pollution, regular watering at the construction sites will be conducted. The appropriate cover will be provided on the construction materials stored at sites and on the trucks to be transported. In addition, Inspection and maintenance of construction vehicles will be regularly carried out.
- Sufficient EHS precautionary signage should be provided.
- Avoiding the areas supporting rare plant/ animal species.

### **3.15 The bank and slope protection works**

- Spilling of earth material in surface water will be avoided.
- Turfing of the slopes with indigenous plant/grass species will be applied to prevent erosion.
- Proper drainage provision will be kept to avoid formation of rain cuts due to surface run off.
- Use of required PPE will be ensured for the workers,

- Proper demarcation, signage and signalling system will be in place.
- EHS manager to check site plan and equipment used at each site prior to start of civil works and review if necessary, and if any special attention/ mitigations required. e.g., noise monitoring.
- Noise- (1) monitor noise level at settlements when they are close to construction site and (2) provide noise barrier if necessary.
- Traffic management at construction site where any works outside the demarcated areas are involved. e.g., temporary closure of a part of road, deployment of guard, etc.
- Wastes generated from construction activities will be segregated and reused/recycled when possible. The remaining wastes will be treated and disposed following the local regulations.
- To reduce dust and air pollution, regular watering at the construction sites will be conducted. The appropriate cover will be provided on the construction materials stored at sites and on the trucks to be transported. In addition, Inspection and maintenance of construction vehicles will be regularly carried out.
- Vegetation/tree clearance will be carried out only when the necessary permits are obtained.
- Sufficient EHS precautionary signage should be provided
- Avoiding the areas supporting rare plant/ animal species.

### **3.16 Re-excavation of drainage channels**

- Unnecessary re-suspension will be avoided by selection of suitable dredging equipment.
- Re-excavated material may be used as embankment material (if necessary and applicable; and if uncontaminated) or will be placed at suitable places, subject to approval of the Engineer.
- Temporary deposition of dredged material will be far from the channel edge to limit damage to streamside and stream habitats.
- Return water will be conveyed through siltation chambers to avoid high loads of fine silt to be discharged in surface water.
- Where applicable biotechnical engineering, for example geo textiles, may be used to help stabilize the material.
- Smothering of important flora and habitats will be avoided (e.g. section wise excavation works, use of quality equipment to avoid vibration and noise).
- EHS manager to check site plan and equipment used at each excavation site prior to start of civil works and review if necessary EHS tools are provided and if any special attention/ mitigation is required. e.g., noise monitoring.
- Noise- (1) monitor noise level at settlements when they are close to excavation

site and (2) provide noise barrier if necessary.

- Traffic management at excavation site where any works outside the demarcated areas are involved. e.g., temporary closure of a part of road, deployment of guard, etc.
- To reduce dust and air pollution, regular watering at the excavation sites will be conducted. The appropriate cover will be provided on the construction materials stored at sites and on the trucks to be transported. In addition, inspection and maintenance of construction vehicles will be regularly carried out.
- Vegetation/tree clearance will be carried out only when the necessary permits are obtained.
- Sufficient EHS precautionary signage should be provided.
- Avoiding the areas supporting rare plant/ animal species.

### **3.17 Risk Assessment for new/additional activities**

Except these construction sites mentioned above, New/additional EHS Risk Assessment may be conducted when the new activities which are not evaluated in the EHS risk assessment come up in the project.

As per the scope of contract agreement and EAP, new/additional activities may be included as below:

- Slope and bank protective works
- Re-excavation of drainage channel
- Closure dam
- Flood wall

### **Description of construction activities**

Due to the risk assessment explained above, Slope and bank protective works only include placing sand, geo-textile, brick chips filter and C.C block. These materials transport to work site by suppliers excluding C.C block which transport by barge or truck of contractor. After the materials arrived to work site, local labours are arranged to place layer by layer according to the shop drawing.

Up to now, re-excavation of drainage channel has completed very little where was easy to conduct. Most area was excavated by excavator excluding little area where hardly excavator worked was conducted manually.

The construction of Closure Dam has not start. After shop drawing and programmer approval, the evaluation of risk assessment for closure dam will proceed.

After completing the earthwork, the contractor shall excavate the foundation work for the RCC floodwalls following the specifications. More earth may be excavated to make space for his/her worker and keeping support to the walls of the trenches. The Contractor shall



provide suitable backfilling to these extra excavations up to the satisfaction of the Engineer.

The RCC flood wall contents four main activities:

- excavation the foundation work manually
- Form work
- M.S work for reinforcement
- Concrete casting
- The risk assessment for all these above works is same with the new replaced sluices.

## 4 Environmental Mitigation Works

The Environment is defined to mean surrounding areas including human and natural resources to be affected by the execution of the project work. We shall take all precaution for safeguarding the environment during the course of construction work.

A provisional sum has been kept in the BoQ for implementation of mitigation works in the form of civil and other works as recommended in the EIA. These items will be implemented as per needs of the project and order of the Engineer.

### 4.1 Non-Compliance Rectification Process

#### **Purpose:**

This section outlines the management of non-compliances and rectification process with its timeframes.

#### **Scope:**

This process applies to the all works of the contractor.

#### **Policy:**

- Contractor is responsible for ensuring all works meet the requirements of EHS guideline.
- The authority (BWDB) and financing agency (WB) deploys personnel to audit/monitor compliance to EHS guidelines, according to the prescribed schedule / or on surprise visits to ascertain compliance.
- EHS officers of Contractor also check the compliance of activities with EIA/ESMP prepared for the project.

#### **Process**

- When a component/task has not demonstrated compliance with the prescribed EHS requirements, the EHS officer will record it as a non-compliance.
- Finalising the audit, the non-compliances will be summarised and discussed, and a timeframe for improvement will be set.
- The above will be recorded and the report will be kept on-site.
- Contractor will report to Consultant on actions taken in their monthly report.
- The next audit will start with a review of the former non-compliances and the corrective actions taken.
- Where tasks/components are found to have non-compliance, with a risk of health, injury or death to workers or outsiders, the auditors will find the likelihood of the risk to occur.
- PMU and EHS manager need to agree on the rectification timeframe in relation to the level of risk to workers and outsiders.

## **5 Social Mitigation measure**

In parallel to the mitigation measures of environmental risks, mitigation measures shall be taken to address the social issues that might be at risk during implementation period of the project. The below listed measures will be implemented as a minimum and can be changed during implementation of work as needed.

### **5.1 Land Acquisition**

Land acquisition shall be done by the Employer. As a part of our social responsibility we shall motivate people regarding potential benefits of the project so that acquisition process is accelerated. We shall, in connection to this process, provide supporting documents (like planning and work progress sheets) if asked for by the Employer.

### **5.2 Squatter Displacement**

The resettlement process will be taken care of by the Employer. We shall make work program in such a way that squatters especially those residing at the toe and slope of the embankment are resettled properly as per World Bank guidelines. We will maintain close contact with the authority regarding this matter.

### **5.3 Labor Influx**

During the execution period of the project a good number of engineers, planners, technicians and laborers of different trade will be required. Local laborers will be given preference for employment. Specialist from different sectors will be hired from Bangladesh and abroad as per project requirement. The level of managers, engineers, supervisors, foreman, plant and machineries operators shall mainly be from Chinese origin. Bangladeshi citizens having requisite expertise shall be engaged considering the work load and progress of work. Gender issues in case of employment of workers shall be taken care of during implementation of the project. Attention shall be given to maintain social and gender equity in terms of salary and other service benefits during implementation period of the project. Child labor shall be strictly prohibitive as per labor law of Bangladesh and WB requirements.

Special care shall be taken regarding transmittable diseases. Initial health screening of the labourers shall be ensured. Laborers have to submit health certificate from prescribed/approved health services to get employed in this project. Bi-annual health check-ups based on random sampling will be arranged for the employees by the employer. The records will be preserved for future references. Communicable disease carriers will not be employed at the working site.

Awareness raising training (in monthly workers training) and prevention measures, particularly against communicable diseases will be conducted. Employees will be under health insurance during the contract period. Employees will be provided insurance for accidents resulting in disabilities or death of employees for the duration of their contracts. The above fact has included in Monitoring Checklist (Annexure: 3-9).

Applicable regulations for labor related matter is in accordance with “The Bangladesh Labour Act, 2006”, “The Bangladesh Labour Act (Amendments), 2013”, and “The Bangladesh Labour Rules, 2015”.

Chinese employees will get relevant permit and visa to work in Bangladesh.

#### **5.4 Tree cutting/felling**

Tree felling shall be done only when required for physical execution of the project. A survey report for trees and plants within the alignment of the project work shall be prepared and shall be submitted to the authority for approval. Proper risk assessment and precaution measures shall be taken during tree cutting. Nearby people shall be informed through hand mike before starting of tree cutting. The above fact has included in Monitoring Checklist (Annexure: 9).

#### **5.5 Discussion with local population in pre- work and during work**

Discussion meetings amongst stakeholders shall be organized by the contractor before commencement of major physical works of the project. Discussion shall be made regarding preventing and solving problems including all stakeholders. The above fact has included in Monitoring Checklist (Annexure: 3-9).

#### **5.6 Communication during work**

Measures shall be taken so that local communication system is not disrupted during implementation of the project. Alternates routes will be selected and prior notice will be served to the community leaders regarding use of alternative routes. If required, by-pass roads and footpaths will be constructed for uninterrupted communication of the local people. Proper signage and signals will be erected at prime locations of the project. The above fact has included in Monitoring Checklist (Annexure: 3-9).

#### **5.7 Grievance Redress Mechanism**

##### **5.7.1 GRM for General Public**

A grievance redress committee will be formed to address any complaints raised by the local people. Grievances from the stakeholders, i.e. affected people, construction workers and civil society members will be addressed; the details of which has been described in Annex-12.

##### **5.7.2 GRM for Workers**

Grievances from workers will be solved following “The Bangladesh Labor Rules, 2015”. Wage related matters will be addressed following rules in Ch. 10 (clause: 111 – 120).

Compensation due to injury related matters will be addressed following rules in Ch. 12 (clause: 134 – 166). It will be checked/monitored monthly by EHS in-Charge of CICO.

## 6 Environmental Management Organization

Our Acting Project Manager will be the first person in-charge of quality, safety and environmental protection. The Environmental Health & Safety In-Charge will be on behalf of us responsible for the specific works, inspection and supervision and reporting to the Engineer periodically. He will be in-charge of environmental compliance for all the 6 Polders of Package W-02. In addition, local EHS officers will act as the core persons to assist the Chinese EHS Managers to be assured the Safeguard policies/practices in CC block manufacturing yard/camp site as well as other work sites. He will make daily tool-box talk before work start. The details are illustrated herewith.

<b>EHS persons</b>	:	<b>Chinese EHS Manager</b>
Educational Qualification	:	Higher Degree/ Post Diploma
Area of Specialization	:	Environmental Science/ Health Safety/ Disaster Management/ Environmental Health/ Coastal Environment/ Environmental Education/Environmental Science/Environmental Changes/Environmental Conservation/ Environmental Development
Experiences	:	At least 5-7 years in relevant field. Special courses on EIA will be added an extra expertise.
Key roles	:	<ul style="list-style-type: none"> <li>• Site set up as per Environmental consequences.</li> <li>• Preparation of EHS document as per guide line of EIA/EMP.</li> <li>• Updated the EHS documents as per instructions of designated Environmentalist of the Project/Donor part.</li> <li>• Preparation of Safety procedures and circulated accordingly.</li> <li>• Site monitoring and discussed with Project Management part.</li> <li>• Make planning accordingly findings/observations of Project authority.</li> <li>• Make Emergency plan and implemented accordingly.</li> <li>• Identify risk area and seeking required mitigation measures.</li> <li>• Preparation of Monitoring Check list and filled accordingly.</li> <li>• Preparation of Safety Signboard and assured the placing.</li> <li>• Liaison with traffic management team.</li> <li>• Liaison with Health Safety team/Local Disaster Management authority.</li> <li>• Environmental Monitoring.</li> <li>• Conducting training for local EHS officer and supervisors.</li> <li>• Reserve the EHS legal documents.</li> <li>• Checking the fortnightly filled inspection check list.</li> <li>• Monitoring the Tool-box/Safety training.</li> </ul>

<b>EHS persons</b>	:	<b>Local EHS Officer</b>
--------------------	---	--------------------------

Educational Qualification	:	Diploma/Equivalent course
Area of Specialization	:	Science/Technical/Applied / Advanced Background
Experiences	:	At least 2 -3 years in relevant field. Working in Construction farm may be counted as special expertise.
Key roles	:	<ul style="list-style-type: none"> <li>• Assist Chinese EHS manager.</li> <li>• Assured the frequent/enough practices for PPE uses in project site.</li> <li>• Assured the efficient waste management system in construction sites/camp.</li> <li>• Environmental data collection/sampling.</li> <li>• Conduction regular tool-box talking.</li> <li>• Conducting periodic safety training for the workers.</li> <li>• Liaison with local community.</li> <li>• Regular checking the signage board.</li> <li>• Assured the pure drinking water facilities.</li> <li>• Assured the FAF for project staff and workers.</li> <li>• Ensured proper sanitation.</li> <li>• Records Keeping.</li> </ul> <p>Maintaining the EHS documents.</p>

A set-up of the responsible staff is given in the following table along with the names and contact details deployed in construction sites:

**Table 6-1 List of designated EHS managers and local EHS officers responsible for Environment and Health Safety**

Location/ Polder	Name	Designation	Contact No.	E-Mail Address
39/2C (Bhandaria, Pirojpur)	Mr. Tang Qiang	Chinese EHS Manager	01709151642	726121403@qq.com
	Mr. Taher	Local EHS Officer	01712003561	
40/2 (Pathorgata, Barguna)	Mr. Bu Shidong	Chinese EHS Manager	01739824919	
	Mr. Tiemur	Local EHS Officer	01818023117	tiemur102@gmail.com
40/2 (Barguna Sadar)	Mr. Tan Qingsong	Chinese EHS Manager	01647239885	
	Mr. Azahar	Local EHS Officer	01797181079	
43/2C (Galachipa, Patuakhali)	Mr. Ning Hailong	Chinese EHS Manager	01678208482	
	Mr. Islam	Local EHS Officer	10850100377	
47/2	Mr. Xiao Yao	Chinese EHS Manager	01646619937	

(Kalapara, Patuakhali)	Mr. Heron	Local EHS Officer	01711668551	heronhasanuzzaman@gmail.com
48 (kalapara, Patuakhali)	Mr. Mi Qi	Chinese EHS Manager	0170518238	
	Mr. Johir	Local EHS Officer	01778124497	
Mr. Chen Haibo, is working as EHS in Charge for Package W-02 from the end of CICO. In previous he was the Chinese EHS Manager for Polder 41/1.				

## 6.1 Schedule for different meetings

### Coordination Meetings:

Coordination between the contractor's personnel and supervising consultant & representative from the employer is important. Informal coordination between the parties to be done using cell phone e-mails etc. Formal coordination meeting in connection with the C-ESMPs implementation/Safeguard policies shall be held once in a month as Monthly EHS meeting as per Office Order of the Project Director vide memo no. CEIP-1/ENV./1329, Date: 29/03/2018. The Contractor is always agreed to be participated in the Monthly EHS meeting either in the Office of the respective BWDB Executive Engineer (Convener of EHS committee) or in PMU office/any suitable places selected by EHS convener. In addition PMU Environmental Specialist executes EHS meeting with respected Polder Manager, Chinese EHS Manager and Local EHS Officer after completion of fortnightly EHS visit at polder level. Frequent conversation also to be held with DDCS & PMS Consultants and Contractors personnel using different medium of communication. Field visit in this regard shall be done as per requirement of the consultant.

**Process to rectify Non-Compliance:** Non-compliance (if there is any) identified by the PMU, DDCS&PMSC and M&E consultants shall be taken care of immediately. A register to be maintained at site containing the issues of non-compliance which shall be promptly reported to the EHS Manager of the Contractor. EHS Manager in consultation with the project Manager will take required measures to rectify the non-compliances identified by the consultant/employer and shall be reported to the consultant/PMU within one month from date of report of any non-compliance.

**Regular Monitoring and review process:** Review of the approved C-ESMPs shall be done periodically. New findings (if there is any) shall be incorporated during the review process of the existing C-ESMPs.

**Training for Capacity Building:** Training is an important tool for capacity building in any sector. Regular training shall be arranged for the capacity building. Training schedule has been described in table 6-2.

**GRM for workers:** Each construction supervisor shall be instructed to maintain a diary to record complains from the workers with specific complain. He will produce the diary daily

to the site Manager to resolve the issue raised by the concerned workers. Site manager in consultation with the EHS Manager and Project Manager will resolve the issue within three days from the date of complain. For any complicated issues the Project Manager himself will be present at site specific location of any site to mitigate the grievance of the workers. All the grievances shall be resolved following the rules as laid down in 'The Bangladesh Labor Rules, 2015'. It also has been reflected in the previous section (Section 5.7.2)

## **6.2 Schedule of different trainings**

Schedule of different trainings for different levels of project personnel and staff are described in the following Table (Table 6.2):

A complete & updated diagram including Chinese EHS manager as well as Local EHS officer for all six Polders under contract Package W-02 is shown in Annexure 21:



**Table 6.2. Preliminary training schedule (To be revised during implementation phase of the physical work)**

Training topics	Trainers	Trainees	Remarks
<p>The training of various EHS topics include education on environmental protection, safety knowledge and precaution against contagious diseases (like AIDS and STD) etc.</p> <p>In order to describe broadly, the major issues include</p> <ul style="list-style-type: none"> <li>• Safety measures to combat Covid-19 pandemic;</li> <li>• Personal safety against Covid-19 pandemic;</li> <li>• Put complain in GCB;</li> <li>• Training for use of PPE;</li> <li>• Training for procedure of equipment operation;</li> <li>• Training for electrical safety and traffic safety and working in high work places;</li> <li>• Training for driver's safety;</li> <li>• Training for use of first aid facilities and fire extinguishers;</li> <li>• Training for CC block dumping;</li> <li>• Training for embankment work and</li> </ul>	<p>Trainers include the Contractors' Environmental officer in Charge, Chinese and local EHS Officers of the concerned Polder.</p> <p>For training on equipment operation, Technician/Engineers were also engaged</p>	<p>The trainees include Local labours, Chinese staffs, Drivers, Equipment operators, Electricians, Mechanics, welders etc.</p>	<p>The Environmental Specialists of PMU, DDCS&amp;PMSC and Third party M&amp;E also provided training during their combined/together visits at work sites.</p>

Training topics	Trainers	Trainees	Remarks
<ul style="list-style-type: none"><li>• Training on incident reporting.</li></ul> <p>The above training are related to safety of working in automated CC plant, sluice construction/rehabilitation, embankment se-sectioning, re-excavation work and CC block dumping works</p>			

Monitoring will help to evaluate the performance of the environmental protection measures as specified in this C-ESMP and with that, the overall effectiveness of environmental and social management.

Monitoring consists of the following:

- Filled Environmental Inspections Checklist.
- Assessment of the inspections (monthly). The electronic/hard copy of the filled Environmental Inspection Checklist/Monitoring Checklist generally shares with the Environmental Specialists of DDCS&PMS Consultant and PMU for assessment. One copy is also reserved in Polder camp site. The third party M&E Environmental Specialist also assess the check list during their Environmental audit/follow up the audit observation.
- Follow-up inspections on corrective actions (when needed). Actually Inspection Check list is the means/indicators to assess the assuring level of Safeguard policies or degree of implementation the proposed mitigation measures cited in EHS risk assessment. Proper follow-up the filled inspection check list is obligatory. The means/way of follow-up the filled inspection check list is as follows:
  - ✓ Maintaining Non-Compliance EHS register separately in CC block yard or other construction sites.
  - ✓ During fortnightly field based EHS visit of PMU Environmental Specialist (deployed at field for better assuring the Safeguard Policies in all types of Construction Site).
  - ✓ During the EHS field visit of DDCS&PMS consultants' Environmental Specialist.
  - ✓ During the EHS field based of PMU Senior Environmental Specialist.
  - ✓ Annual Environmental Audit conducting by the third party M&E consultant for overall monitoring the project.
  - ✓ Monthly EHS meeting.
  - ✓ Package wise review meeting as conducted by DDCS&PMS consultant.
  - ✓ During the EMP monitoring by CRTS, KUET.
  - ✓ Polder based monthly progress meeting of CICO.
  - ✓ EHS visit furnished by EHS in Charge of CICO.

The filled fortnightly Environmental Inspections by the Chinese EHS Manager will generate the primary set of monitoring data that will be used to evaluate the effectiveness of environmental and social management and to demonstrate compliance with the Contract Specifications and implementation of C-ESMP.

Monitoring Reports /Records will be kept in an orderly manner and easily accessible to all concerned parties for the full period of construction. Documents (or copy of these) like workers' register, design drawings, etc., will be kept safely at work sites.

The following documents will be kept in our local offices (per Polder):

- Results of Environmental Inspections.
- Register of complaints.

The following records regarding environmental management issues will be kept by Chinese EHS Manager at Polder Site/ Contractor main Field Office at Patuakhali:

- All necessary permits, including borrow area approvals, private landowners' permission for activities on their land, etc.
- Training Records (attendance lists).
- Register of non-compliance and corrective actions proposed.
- Monthly environmental evaluation reports.
- Correspondences.

Complaints received from the public or other stakeholders will be registered and recorded by the Chinese EHS Manager and brought to the attention of the Polder Manager. The following information will be recorded in the case of any complaint:

- Time, date and nature of complaint.
- Response and investigation undertaken.
- Designated responsible persons who already resolved the complaints.
- As per advice of the Senior Environmental Specialist of the World Bank during his Safeguard Visit on May 2 to 3, 2019, the contractor already provided "**Complain Box**" in each CC block yard and opened a complaint register in each construction site under contract Package W-02. Local EHS officer informs supervisors/workers regarding the location of "**Complain Box**" in CC block casting yard.

All complaints will be investigated and are response is to be given to the complainant within 7 days of receipt (**Stage 1**). EHS in-Charge of CICO will act as key person to be resolved the Complaints.

PMU Environmental Specialist will investigate the issues during his fortnightly EHS visits at field level and give his observations in written form (**Stage 2**).

If contractor does not resolve the complaints, Environmental Specialists of PMU as well as DDCS&PMS consultant will handle the issues to be solved the complaints based on the discussion made with Acting Project Manager of CICO (**Stage 3**).

If the Environmental Specialists are not able to resolve the Complaints, finally Project Director will be responsible for and take necessary actions to resolve the raised complaints (**Stage 4**). This is the top-notch efforts for resolving the Complaints in contract Package W-02.

### Information on Grievance Collection Boxes (GCBs)

In Package-2, Polder-wise GCBs are, in Polder 39/2C there are 3 nos. of GCBs (at and around the 3 automated CC block manufacturing plants), in Polder 40/2 there are 2 nos. of GCBs. (1 at camp site and 1 at mechanical room), in Polder 41/1 there are 2 nos. of GCBs (1 at inside the camp and 1 at entrance of camp), Polder 43/2C has 2 nos.(1 at camp site and another placed in mechanical workshop site), Polder 48 has 3 nos (1 outside store room, 1 outside generator room and 1 outside mechanical room). The information of GCBs is submitted as follows:

### Information on grievances of the GCBs in Package-2

Sl. No.	Location	Name of the person, who keeps the key	No. of Grievance received	Action taken	Remarks
1.	Polder 40/2	Md. Shohel Rana, Field Engineer	Nil	-	All boxes are opened by Engineers' representatives
2.	Polder 40/2	Md. Shohel Rana, Field Engineer	Nil	-	
3.	Polder 41/1	Khnadaker Shamim Ahmed, Field Engineer	Nil	-	
4.	Polder41/1	Khnadaker Shamim Ahmed, Field Engineer	Nil	-	
5.	Polder 43/2 (at Chinese camp)	Mr. Md. Harunur Rashid, CSE, Polder 43/2	Nil	-	All boxes are opened by Engineers' representatives
6.	Polder 43/2 (at Mechanical shed)	Mr. Md. Harunur Rashid, CSE, Polder 43/2	Nil	-	
7	Polder 48	Mr. A.K.M. Mazibur Rahman,	Nil	-	All boxes are

Sl. No.	Location	Name of the person, who keeps the key	No. of Grievance received	Action taken	Remarks
	(outside store room)	(Polder 47/2 & 48)			opened by Engineers' representatives
8	Polder 48 (outside generator room)	Mr. A.K.M. Mazibur Rahman, (Polder 47/2 & 48)	Nil	-	
9	Polder 48 (outside mechanical room)	Mr. A.K.M. Mazibur Rahman, (Polder 47/2 & 48)	Nil		

All types of physical incidents occurring on the site will be recorded in an Incident Register. The following information will be provided:

- Time, date and nature of incident.
- Response and investigation undertaken.
- Corrective and preventative actions taken and by whom.

The environmental incidences will be immediately reported to the Engineer such as damage to land/structures, spills of hazardous materials, or other incidents which are likely to cause pollution and other detrimental environmental effects or loss or damage to private resources.

#### **Recording of Workers' History**

The Contractors of Package-2 are keeping/ maintaining various records of their workers specially information on their age, gender, medical history, contact details of next of kin to notify in case of accident and emergency. The recording is monitored by the Environmental Specialists of PMU, DDCS&PMS Consultants and Third-party M&E Consultants during their visits at field level.

### **INCIDENT MANAGEMENT AND REPORTING PROCESS**

This Environment and Social Incidents Response Toolkit (ESIRT) for Coastal Embankment Improvement Project (CEIP-1) has been prepared following ESIRT for World Bank Staff and existing incident reporting system of the Project. The existing incident reporting system has been synchronized with the World Bank's ESIRT. The document is intended for better as well as timely updated the incidents that occur during implementation of works at sites. It aims to help organize and systematize the response to incidents, and to foster learning to help design approaches and measures to reduce similar incidents occurring in construction sites. The Coastal Embankment Improvement Project, Phase 1 (CEIP-1) of Bangladesh Water Development Board (BWDB) has developed this ESIRT with an aim to confirm the timely reporting the occurrence regard to Environment & Social and minimizes the replication. The Toolkit comprised of the following six steps under the incident management and reporting process. This ESIRT also contains a Section on Responses and Remedial Actions are being already adopted for the construction sites of Package W-02 under CEIP-1 included C-ESMP respectively. The incident management and reporting process provide a clear pathway to alert the right people according to the severity of the incident to help in achieving an effective and appropriate response. The incident management and reporting process comprises six steps (see Figure 1 below). Each step also includes a sub-set of activities. Tools and templates have been designed to support specific activities in the process.

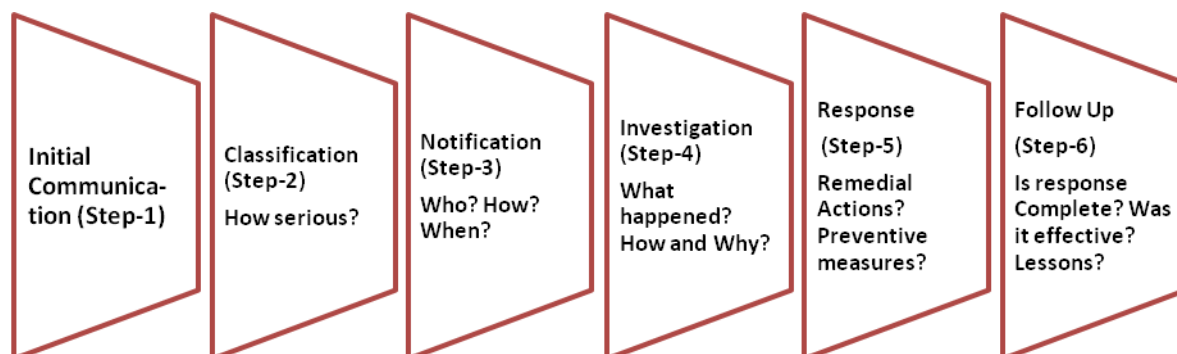

**Figure 1 - Incident Management and Reporting Process**

## **STEP 1: INITIAL COMMUNICATION**

The following process should be followed once the Task Team becomes aware of an incident. The contractor is to communicate the occurrence irrespective of minor and severe at site to their management as described in Annexures

**Action:** Occurrence of Incident. Contractor is to inform immediately after occurrence of the incident to the site Engineer with a description and what help or action to be taken. If it is beyond the capacity of site Engineer he/she will inform to PMU/BWDB through TL/DTL for action or remedy.

**PMU/BWDB's role:** For any severe incident, and for all other types of incident after Project Director evaluates, he/she will inform to Bank; inform appropriate authorities in compliance with local govt; secure the safety of workers, public, and provide immediate care

When an incident is reported, the following enquiries need to be included as follows:

- What was the incident? What happened? To what or to whom?
- Where and when did the incident occur?
- What is the information source?
- How did we find out about the incident?
- Are the basic facts of the incident clear and uncontested, or are there conflicting versions?
- What were the conditions or circumstances under which the incident occurred?
- Is the incident still ongoing or is it contained?
- Is loss of life or severe harm involved?
- How serious was the incident? How is it being addressed? How is the Borrower responding?
- What, if any, additional follow up action is required, and what are the associated timelines?
- Is there any safety protocol in the incident site?



## **STEP 2: CLASSIFICATION-Assessing the severity of the incident**

Classifying the incident will guide decisions as to who in the Bank should be informed, and what resources are needed to understand the incident and support the Borrower in addressing the underlying cause(s). Classification must be done as rapidly as possible, so that the Bank is able to respond to the incident within a reasonable time-frame. The incident should be classified within 48 hours of receipt of the information, within 24 hours will be preferable if possible. If it cannot be fully classified due to missing information, then a preliminary classification should be provided and confirmed as details become available. The classification is based on several factors, including the nature and scope of the incident, as well as the urgency in which a response may be required.

Action: Incident Classification

PMU/BWDB role: Promptly provide information about the incident to the Bank as well as further details as they become available.

There are three levels of incident classification:

- **Indicative**
- **Serious**
- **Severe**

### **Indicative:**

- A relatively minor, small-scale, localized incident that negatively impacts a small geographical area or a small number of people and does not result in significant or irreparable harm to people or the environment.
- This type of incident may be indicative of wider-scale issues or underlying organizational weaknesses within a project that could lead to serious or severe incidents if left uncorrected.
- Indicative incidents can be investigated, evaluated, managed, and resolved by the Contractor or Borrower using existing, project-level resources and with the support of the Task Team.

### **Serious:**

- An incident that caused or may cause significant harm to the environment, workers, communities, or natural or cultural resources.

- It is complex or costly to reverse and may result in some level of lasting damage or injury; or failure to implement E&S measures that may potentially cause significant impacts.
- Examples of serious incidents may include injuries to workers that require off-site medical attention, exploitation or abuse of vulnerable groups, consistent lack of Operational Health and Safety (OHS) plans in a civil works project and large scale deforestation. Serious incidents require an urgent response and could pose a significant reputational risk for the Bank

•

**Severe:**

- Incidents that caused or may cause great harm to individuals or the environment, or present significant reputational risks that could hamper the Bank's ability to operate in a country or region.
- A severe incident is complex and expensive to remedy (if possible), and is likely irreversible.
- A fatality is automatically classified as severe, as are incidents of major environmental contamination, forced or child labor, abuses of community members by project security forces or other project workers (including GBV) violent community protests a project, kidnapping, and trafficking in endangered species.

•

• **Incident Classification Guide**

•

<b>Indicative:</b>
<ul style="list-style-type: none"> <li>• Relatively minor and small-scale localized incident that negatively impacts a small geographical areas or small number of people</li> <li>• Does not result in significant or irreparable harm</li> <li>• Failure to implement agreed E&amp;S measures with limited immediate impacts</li> </ul>
<b>Serious:</b>
<ul style="list-style-type: none"> <li>• An incident that caused or may potentially cause significant harm to the environment, workers, communities, or natural or cultural resources</li> <li>• Repeated non-compliance with E&amp;S policies incidents</li> <li>• Non-compliance that may potentially cause significant impacts</li> <li>• Is complex and/or costly to reverse</li> </ul>

<ul style="list-style-type: none"><li>• May result in some level of lasting damage or injury</li><li>• Requires an urgent response</li><li>• Could pose a significant reputational risk for the Bank.</li></ul>
<b>Severe:</b>
<ul style="list-style-type: none"><li>• Any fatality</li><li>• Incidents that caused or may cause great harm to environment, human life.</li><li>• Serious non-compliance that cannot be reversed</li><li>• Serious non-compliance that costly to reverse</li><li>• May result in high levels of lasting damage or injury</li><li>• Requires an urgent and immediate response</li><li>• Poses a significant reputational risk to the Bank.</li></ul>

The Incident Report should be 1-2 pages and include, at a minimum, the following information:

- Country, Name of Project ( Number), Name of TTL and E&S specialists assigned to the team
- Preliminary classification of the incident
- What was the incident? What happened? To what or to whom?
- Where and when did the incident occur?
- When and how did we find out about it?
- Are the basic facts of the incident clear and uncontested, or are there conflicting versions?
- What are those versions?
- What were the conditions or circumstances under which the incident occurred (if known at this stage)?
- Is the incident still ongoing or is it contained?
- Is loss of life or severe harm involved?
- Is the Borrower aware of the incident? What is their response to date?
- What measures have been or are being implemented by the Borrower/Contractor?

**STEP 3: NOTIFICATION-Who needs to know about the incident?**

The contractor will notify the consultants & employer/BWDB about incidence occurring while completed the categorization of the incidence and formulating the incidents report. The employer will share the facts with the WB within 24 hours after getting the report from consultants as well as contractor and responsible for investigation.

Action: Notify Bank management according to severity of the incident

- PMU/BWDB role: BWDB will report the incident to the Bank. Prior, the contractor should report incidents to the BWDB – the BWDB should ensure that reporting obligations on compliance with ESHS requirements are incorporated into works and other relevant contracts. Borrower should monitor the reports for incidents. Follow national requirements for incident reporting and management

**STEP 4: INVESTIGATION**

It is important to note that the employer/BWDB is responsible for carrying out investigations of incidents. The Bank is responsible for ensuring that appropriate investigations are conducted as needed. They process are here in Figure 2. Basically the employer/BWDB & consultants will complete the investigation within very short and reasonable period. The bank will check the investigation report and conduct further investigation if required.

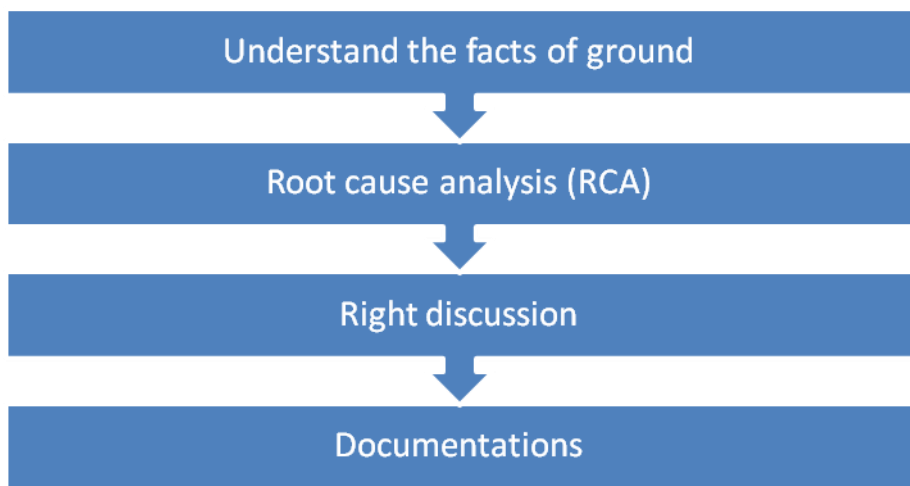

**Figure 2 - Investigation procedure of incidence in construction sites**

**PMU/BWDB role:** Promptly provide information requested by the Bank and facilitate incident site visits. Undertake or cause the Contractor to undertake a RCA to understand and document the root cause(s) of the incident. The RCA should be based on existing country processes. An RCA should be completed as soon as possible, ideally within 10 days of the incident. The findings of the RCA should be used by the Contractor and Borrower to develop measures **14 | Page Action** Bank Role Borrower Role required remedial measures based on the findings of the RCA to be included in a Safeguards Corrective Action Plan (SCAP). Share the RCA with the Bank and provide complete information about the incident; facilitate additional site visit(s) if needed

#### **STEP 5: RESPONSE**

For Indicative incidents, documentation of the incident and the Borrower/Contractor response may be the only action required. For serious and severe incidents, where an RCA or other investigation is conducted by the Borrower/Contractor, the Bank and the Borrower agree on a set of measures as appropriate to address the root causes to help prevent any recurrence of the incident. Response from employer/BWDB and bank will make the contractors more capable for avoiding replication of incidence. It will also stipulate the contractor for taking immediate actions against incidence and enhanced the monitoring systems of consultant. Without right and timely response the whole systems will be inactive & there will be chance for further incidence. Sometimes there will be demand for developing new safeguard documents or updating the existing EHS documents, which could be implemented in the construction sites.

#### **STEP 6: FOLLOW-UP**

Follow-up process will contribute to achieve the ultimate aim and goal of ESIRT. Different kind of reporting in the existing reports will confirm the proper implementation in construction sites. It will minimize the amount of incidences and ensure the right as well as proper remedial measures for happening any kind of incidence. It will confirm the Proper Compensation (if required) as well as remedies. Ultimately secured environment will build for all on-going construction sites of CEIP-1.

## 7 Contingency Planning

The objective of a Contingency (Emergency Preparedness and Response) Plan is to establish and define the actions to control/mitigate the occasional accidents and natural or human threats during project construction. It must provide efficient and immediate response for any emergency and it must guarantee the safety of all personnel of the project and third parties. A detailed and quantitative risk analysis will be conducted to inform the Contingency Plan. A draft Emergency Plan is attached in Annex-14 and will be updated before work starts. The plan will cover the following:

Planning Coordination: This should include procedures for:

- Informing the public and emergency response agencies.
- Documenting first aid and emergency medical treatment.
- Taking emergency response actions.
- Reviewing and updating the emergency response plan to reflect changes and ensuring that the employees are informed of such changes.

Emergency Equipment: The plan should include procedures for using, inspecting, testing, and maintaining emergency response equipment.

Training: Employees should be trained in any relevant procedures.

**Basic elements are:**

- Administration (policy, purpose, distribution, definitions, etc.)
- Organization of emergency areas (command centers, medical stations, etc.)
- Roles and responsibilities
- Communication systems
- Emergency response procedures
- Emergency resources
- Training and updating
- Checklists (role and action list and equipment checklist)
- Business Continuity and Contingency
- 

**Areas of attention are among others:**

- Preparedness for natural disasters (floods, storms leading to e.g., breach of embankment etc.
- Preparedness for fire prevention and control, road accidents, fuel spills, etc.

---

## **8 Contractor's Environmental and Social Management Plan Monitoring Checklist**

Extensive monitoring of the environmental concerns of the CEIP-1 project is required as per World Bank EHS-guidelines. The monitoring program will help to evaluate: (i) the extent and severity of the environmental impacts against the predicted impacts and baseline; (ii) the performance of the environmental protection measures or compliance with pertinent rules and regulations; (iii) trends in impacts; and, (iv) overall effectiveness of the project environmental protection measures.

Monitoring Checklist for each project activity including general site mobilization activity is given at the end of the plan. The checklists have been named as 'Monitoring checklist for general site mobilization activity-Annexure-3, Monitoring checklist for Re-sectioning of embankment -Annexure-4, Monitoring checklist for Bank protection work -Annexure-5, Monitoring checklist for Construction( Replacement) of Drainage/Flushing Sluice -Annexure-6, Monitoring checklist for Re-excavation of Drainage khal -Annexure-7, Monitoring checklist for Flood Wall Construction -Annexure-8, Monitoring checklist for Afforestation -Annexure-9, Monitoring checklist for Demobilization -Annexure-10'.

Each Checklist shall be detailed and be made location/chainage specific at the beginning of each physical work and approval shall be taken before commencement of any physical work.

## Annex-1: Overview Works Polder-40/2

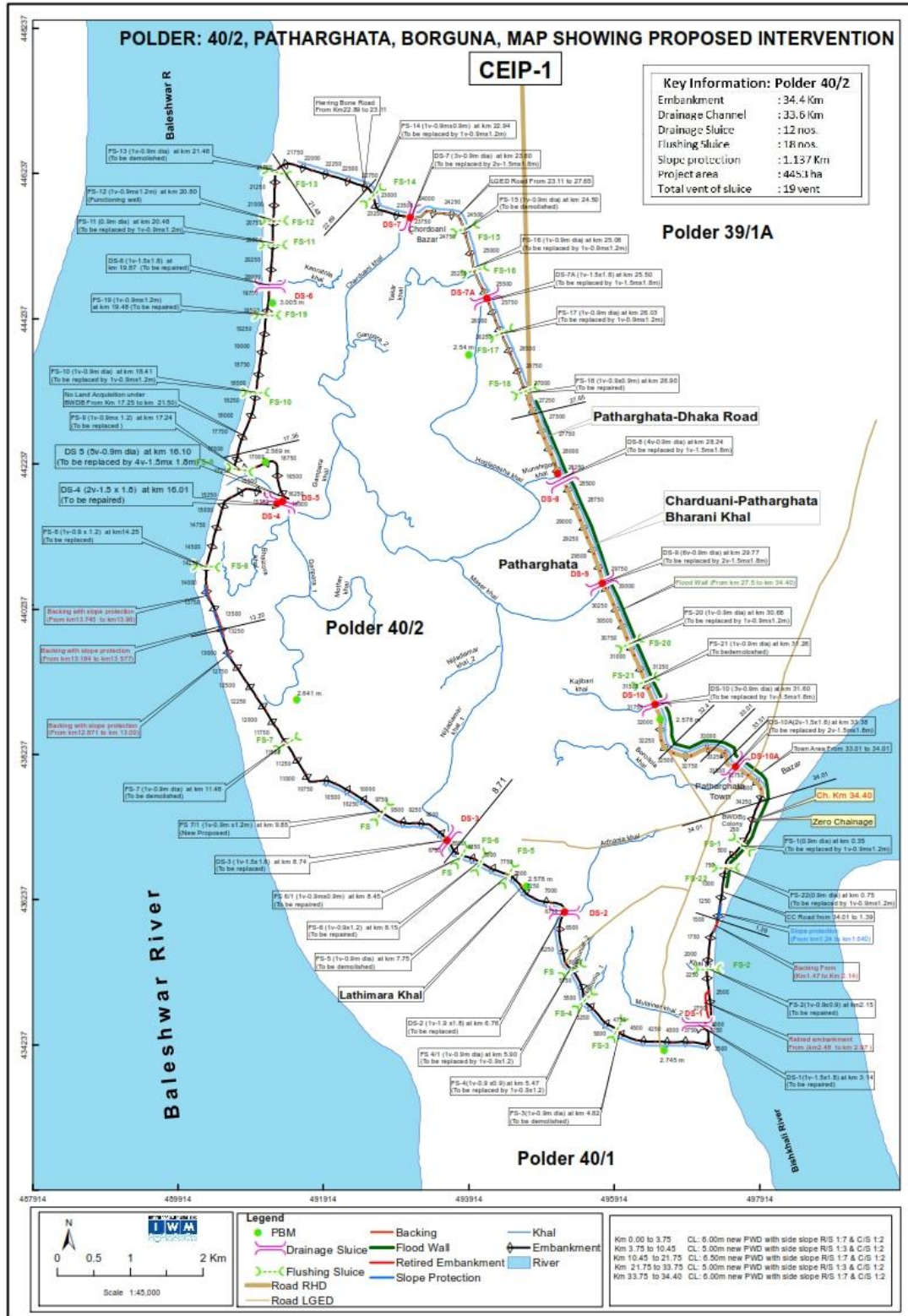

D:\P0020\51566\_CCEIP\MXD\FWP40\_2\F40\_2\_091115\_gha.mxd



## **Annex-2: Update progress CEIP-1 Contract W-02**

Work of Package-2 is also in progress since the contract that was awarded on 15 December 2016, signed on 08 March 2017 and notice to commence issued on 12 July 2017. Mobilization and ancillary works along with inception and progress of physical works in 6 Polders under Package 02 have commenced, although progress in Polder 43/2C has been delayed due to land acquisition issues mainly (where physical work started from January 1, 2019).

The key activities and accomplishments of works of Package 02 during July- December, 2021 were construction/ re-sectioning of embankment, construction/repair of drainage sluices, construction/repair of flushing sluices, excavation/re-excavation of drainage channel, embankment slope protection and River bank protection works.

Work progress achieved during/ up to the reporting period has been mentioned below:

Construction/re-sectioning of embankment completed in 66.498 kms and it is ongoing in 36.476 kms with an overall progress of 49.82% of total length of 208.101 kms

Excavation of drainage channel has been completed in 78.658 kms with overall progress of 72.03% of total length of 154.931 kms.

Construction of 19 drainage sluices completed and work ongoing in 28 nos. by December, 2021 of total 51 nos. with overall progress of 81.82 % as compared with 18 nos. completed and ongoing in 25 nos. by June, 2021 with overall progress of 78.96%.

Construction of 12 nos. of flushing sluices completed and work ongoing in 20 nos. by December, 2021 with overall progress of 56.32% out of total 51 nos. as against 12 nos. completed and ongoing in 12 nos. with an overall progress of 49.02% by June 2021

Repair of Drainage Sluices ongoing in 2 nos. against total 6 nos. with an overall progress 59.76%.

Repair of 1 Flushing Sluice completed and ongoing in 21 numbers out by December with an overall progress of 67.35% as against 1 no. completed and ongoing in 17 nos. with an overall progress 61.09% by June, 2021

Slope Protection works have been carried out in 1.850 kms by December, 2021 as against completed in 1.700 kms by June 2021 out of total 9.476 kms.

River bank protection works have been carried out in 4.654 kms out of total 5.691 kms with a progress of 89.72% by December, 2021 whereas it was done in 4.425 kms (82.15%) by June,2021.

Manufacturing of CC blocks is in progress in all Polders and 6,861,079 numbers (87.90%) have been produced by end of December,2021 which was 6,054,052 numbers (77.56%) by June, 2021.

### Annex-3: Monitoring Checklist for General Site Mobilization Work and CC block manufacturing plant

<p><b>Name of the Project: Coastal Embankment Improvement Project, Phase-1</b></p> <p><b>Contract Package No: W-02</b></p> <p><b>Name of Polder: 40/2</b></p>	<p><b>Name of Activity: General Site Mobilization Work</b></p> <p><b>Location:</b></p> <p><b>Date of Inspection:</b></p>
---	--

SI No.	Activities/ Aspects	Actions to be taken / Inspection items	Monitoring Frequency (1,D,W,M,Y*)	Means of monitoring	Compliant(Y/N) Repeating on- compliance(R)			Remarks
					Y	N	R	
01.	Construction of Base camp	<ul style="list-style-type: none"> <li>• Obtaining approval for facilities construction work</li> <li>• Erection of signboard in Bangla and English with project details</li> <li>• Install accommodation facilities for Engineers and other staff/workers</li> <li>• Drainage channels installation</li> <li>• Supply of safe drinking water</li> <li>• Supply of adequate sanitation facilities</li> <li>• Safety fencing/Barriers and Entry Kiosks</li> <li>• Stack yard for plant and equipment</li> <li>• Construction of store room/warehouse</li> <li>• Temporary workshop facilities</li> <li>• Arrangement of sufficient lighting facilities in the camp area</li> <li>• Safety protocols and measures for using electrical appliances</li> <li>• Solid fencing and demarcation to prevent villagers from entering the premises</li> </ul>	Before Work start	Document Field visit				
2	Precast CC blocks	<ul style="list-style-type: none"> <li>• Provide noise control barrier around the plant</li> </ul>	Before work start					

SI No.	Activities/ Aspects	Actions to be taken / Inspection items	Monitoring Frequency (1,D,W,M,Y*)	Means of monitoring	Compliant(Y/N) Repeating on- compliance(R)			Remarks
					Y	N	R	
		<p>area as possible</p> <ul style="list-style-type: none"> <li>• Spray water at certain intervals in the mixture machine area</li> <li>• Wet and clean the aggregate before using</li> <li>• Cover/wet dusty parts or materials</li> <li>• No operation without the screen or barrier provided with the machine</li> <li>• Conduct toolbox talk regularly</li> <li>• Establish and practice the safe operation procedure</li> <li>• Regular checking of mixture machine</li> <li>• Check electric switch, fuel and all types connection line during off and on of mixture machine.</li> <li>• Preserve the key of mixture machine with the designated person only</li> <li>• Conduct proper repair, whenever required</li> </ul> <p>Use ear plug and ear muff before starting the mixture machine</p> <ul style="list-style-type: none"> <li>• Spray water at during intervals at stockpile areas</li> <li>• Wet/cover the sand or aggregate storage at stockpile areas</li> </ul> <ul style="list-style-type: none"> <li>• Make stockpile area as no entry zone</li> <li>• Provide cautionary signboard at stockpile areas</li> <li>• Demarcate the CC block stacking area</li> <li>• Provide cautionary signboard at CC block stacking areas</li> <li>• </li> <li>• Regular check the switch board and weir</li> </ul>						

SI No.	Activities/ Aspects	Actions to be taken / Inspection items	Monitoring Frequency (1,D,W,M,Y*)	Means of monitoring	Compliant(Y/N) Repeating on- compliance(R)			Remarks
					Y	N	R	
		system <ul style="list-style-type: none"> <li>• Turn off the main switch board</li> <li>• Use the fire-extinguisher and sand as required</li>   <li>• Rise the wire system up or underground conduit system should be established</li> <li>• All joint will be insulated</li> <li>• Closed all the switch board properly. Only responsible person will check at regular intervals</li> <li>• Provide the gas mask properly during welding</li> <li>• Provide special cloth for welding</li> <li>• Provide the eye protective welding glass</li> <li>• Maintain a minimum distance (6.1 m) from the fuel gas cylinder</li> <li>• Check the hose pipe system regularly</li> <li>• Workers will be equipped with proper PPE.</li> <li>• Signals will be installed to indicate the entry and exits and movement of vehicles in the work area.</li> <li>• Stacks with sand will be covered or wetted.</li> <li>• Use hand gloves during operation</li> <li>• Check the plate joint regularly, about its stability</li> <li>• Spray water during intervals</li> <li>• Wet the sand or aggregate</li> <li>• Worker's standing area should maintain certain distance from the loading and unloading area</li> </ul>						
03	Fuel storage area Management	<ul style="list-style-type: none"> <li>• Establish fuel storage shed at each work site and CC block plant</li> <li>• Install hardstand and secondary containment for oils and chemicals stored/used</li> </ul>	Prior to be installed	Field visit				

SI No.	Activities/ Aspects	Actions to be taken / Inspection items	Monitoring Frequency (1,D,W,M,Y*)	Means of monitoring	Compliant(Y/N) Repeating on- compliance(R)			Remarks
					Y	N	R	
		<ul style="list-style-type: none"> <li>• Fire fighting equipment installation and check expiration dates of hydrants</li> <li>• Place sand and shovel close-by Inflammable substances should be placed away from source of heat and fire</li> <li>• The Material Safety Data Sheet (MSDS) from supplier of hazardous substances (diesel, oil, lubricant) to be placed besides containers/storage.</li> <li>• Keep Spill kit/absorbent mat to catch any spilled fuels at the location where potential spillage may occur.</li> <li>• Sufficient hydrants to address potential fire should be equipped at fuel storage area as well as the areas where chemicals/fuels are used.</li> <li>• Regular checks on physical condition</li> <li>• Maintain minimum distance during fuelling and fuelling</li> </ul>		Document				
04.	Welding area	<ul style="list-style-type: none"> <li>• Paved welding area,</li> <li>• Enough safety procedure for different type of works,</li> <li>• The safety rules are implementing through discussion as a "Tool-box talking" and</li> <li>• Fire extinguisher mentioning validity period</li> </ul>						
05.	Cylinder management	<ul style="list-style-type: none"> <li>• The cylinders are kept on designated room in good manner,</li> <li>• Safety procedure for using Oxygen gas,</li> <li>• Erection of cautionary signboard and</li> <li>• Fire extinguisher mentioning validity period.</li> </ul>						
06.	Access road to the base	<ul style="list-style-type: none"> <li>• Obtaining approval</li> </ul>	1	Document				

SI No.	Activities/ Aspects	Actions to be taken / Inspection items	Monitoring Frequency (1,D,W,M,Y*)	Means of monitoring	Compliant(Y/N) Repeating on- compliance(R)			Remarks
					Y	N	R	
	camp	<ul style="list-style-type: none"> <li>• Construction of culverts if needed</li> <li>• Construction of temporary road/by pass road</li> <li>• Install speed limit signs</li> <li>• Entry &amp; Exit signs</li> </ul>	1 1 1 1	Field visit				
07.	Training	<ul style="list-style-type: none"> <li>• Environmental training on EMP will be arranged for Management level, Chinese EHS Manager, Local EHS Officer, Construction Supervisors, Foreman, Plant operators, Drivers and Workers.</li> <li>• Monitor number of new workers receiving OHS training</li> <li>• Monitor number workers receiving training, dates of training</li> </ul>	M/Y  6M 6M	Document				
08.	Occupational Health and Safety	<ul style="list-style-type: none"> <li>• Development of Health and Safety Plan including emergency procedures</li> <li>• Train all staff in health and safety</li> <li>• Provision of HIV, including STI (sexually transmitted infections) information, education and communication.</li> <li>• Provision of PPE and ensuring their use (% of workers using full PPE, partial)</li> <li>• Provision and use of life jacket during visiting campsite/work site by boat (number of life jacket available, number of people on board of boat)</li> <li>• Installation of first aid facilities at work site and camps with adequate stock</li> <li>• Provide sanitation facilities where needed (Number of users/facility, conditions)</li> <li>• Provision of safe drinking water to work force (tube-well water, bottled water or pond water)</li> <li>• Proper signalling of work areas</li> <li>• Health screening of each worker (and every new worker) with proper documentation</li> </ul>	1 6M 1 M M 1 1 W M M	Document Document Field visit Ditto				

SI No.	Activities/ Aspects	Actions to be taken / Inspection items	Monitoring Frequency (1,D,W,M,Y*)	Means of monitoring	Compliant(Y/N) Repeating on- compliance(R)			Remarks
					Y	N	R	
		<ul style="list-style-type: none"> <li>• Tool box talk is conducted everyday</li> <li>• Site plan is reviewed by the environmental manager of contractor before commencement of the work.</li> </ul>	D Y					
09.	Public Health and Safety	<ul style="list-style-type: none"> <li>• Notification of the public adjacent to the construction areas</li> <li>• Installation of dedicated pathways for pedestrians</li> <li>• Proper signalling of work areas</li> <li>• Limitation of construction vehicles at public roads during peak hours.</li> <li>• The temporary traffic detours in settlement areas will be kept free of dust by frequent application of water.</li> <li>• Construction activities will be undertaken according to during daylight working hours between the hours of 07:00 – 17:00 on weekdays.</li> <li>• Minimize dust by wetting pedestrian pathways</li> <li>• Inform GRM</li> </ul>	M Y M M W W D M	Field visit				
10.	Water Supply	<ul style="list-style-type: none"> <li>• Providing construction camps with potable water either through installing tube wells (hand pump, shallow and deep tube well), Pond Sand Filter (PSF) or supplying safe bottled water.</li> <li>• Ensuring the location plan of tube wells (used for supplying potable water) that these are not sited near any sanitation facilities as to avoid water pollution.</li> <li>• Maintaining the distance of a tube well / surface water resource from a soak pit at minimum 15m.</li> <li>• Maintaining the drainage from the tube well</li> </ul>	1 1 1 Y	Field visit				

SI No.	Activities/ Aspects	Actions to be taken / Inspection items	Monitoring Frequency (1,D,W,M,Y*)	Means of monitoring	Compliant(Y/N) Repeating on- compliance(R)			Remarks
					Y	N	R	
		diverting into the drainage system of the camp area. • Providing separate tube wells for the use of women.	1					
11	Sanitation	<ul style="list-style-type: none"> <li>• Providing suitable sanitation facilities for the workforce.</li> <li>• Ensuring the location plan of the latrine at least 50 meter away from the accommodation facility.</li> <li>• Providing separate latrines for the use of women.</li> <li>• Installing treatment facilities (i.e. septic tank, soak pits etc.) for sewerage of toilet and camp site wastes.</li> <li>• Arranging disposal of wastewater from washrooms, kitchens, s, etc. via the camp area's drainage system</li> </ul>	1 1 1 1 1	Field visit				
12	Solid Waste Management	<ul style="list-style-type: none"> <li>• Ensuring collection and disposal of solid wastes within the construction camps and work areas</li> <li>• Take measures to collect and store inorganic wastes in a safe place within the household and organic wastes cleared on daily basis to waste collector. (quantity/ number and size of bins)</li> <li>• Establish measures for waste collection, transportation and disposal systems at approved disposal sites. (register disposal time and means)</li> <li>• Disposal of construction and demolition waste. (quantity, location, by whom)</li> </ul>	M M 1 M	Field visit  Document				
13.	Industrial Waste Management	<ul style="list-style-type: none"> <li>• Make temporary Industrial Waste storage area</li> <li>• The area should be paved, defined with shade</li> <li>• Erection of cautionary signage regarding <b>"Industrial Waste Storage Area"</b>, <b>"No Entry"</b>, should be erected in site.</li> </ul>	Prior to install					



SI No.	Activities/ Aspects	Actions to be taken / Inspection items	Monitoring Frequency (1,D,W,M,Y*)	Means of monitoring	Compliant(Y/N) Repeating on- compliance(R)			Remarks
					Y	N	R	
		<ul style="list-style-type: none"> <li>• Categorized the waste</li> <li>• Proper disposal</li> <li>• Record keeping</li> </ul>						
14	Chemical storage area management	<ul style="list-style-type: none"> <li>• Make temporary Chemical storage area</li> <li>• The area should be paved, defined with shade</li> <li>• Install the required Sign=board</li> <li>• Erection of cautionary signage regarding "Chemical Storage Area", "No Entry", should be erected in site.</li> <li>• Kept in closed condition</li> <li>• Tray as well as spill kit/absorbent mat should be provided in chemical storage area.</li> <li>• Material Safety data sheet (MSDS) should be provided in this storage area.</li> <li>• Necessary numbers of fire extinguisher</li> </ul>	Prior to install					
15.	Wastewater	<ul style="list-style-type: none"> <li>• Installation of decanter boxes for washing buckets and cement mixers</li> <li>• Installation of proper filtering elements.</li> <li>• Carrying out periodic checks and clean-ups for the decanter box.</li> <li>• Prioritize reuse of aggregates and water from the decanter box.</li> <li>• Ensure safe disposal of liquid wastes generated at camp site.</li> </ul>	1  1 M  M  M	Field visit				
16.	Electrical Safety	<ul style="list-style-type: none"> <li>• Clearly visible notification on the safe use of electrical appliances</li> <li>• Check all wirings to prevent any accident, fire due to short circuit</li> <li>• Rise the wire system up or underground conduit system should be established</li> <li>• Regular check the switch board and wire system</li> </ul>	Prior to be installed					

SI No.	Activities/ Aspects	Actions to be taken / Inspection items	Monitoring Frequency (1,D,W,M,Y*)	Means of monitoring	Compliant(Y/N) Repeating on- compliance(R)			Remarks
					Y	N	R	
		<ul style="list-style-type: none"> <li>Close all the switch board properly. Only responsible will check at regular intervals</li> <li>Cover the joint by tape or other insulating materials</li> </ul>						
17.	Air	<ul style="list-style-type: none"> <li>Regular maintenance of vehicles</li> <li>Covering or wetting of dusty materials</li> <li>Dust suppression by wetting surfaces</li> <li>Impose speed limits</li> <li>Re-vegetate bare surfaces soonest</li> </ul>	M M W W M	Field visit				
18.	Monitoring of Air Quality	<ul style="list-style-type: none"> <li>Performance of air quality tests at selected sensitive sites for parameters SPM2.5/10 during working hours.</li> <li>Number of working blowers</li> <li>Number of watering per day</li> <li>Number of complains on air quality</li> <li>Warnings given by environmentalist</li> <li>Actions taken to resolve</li> <li>Highlights of quarry dust control (covers, sprays, operational status)</li> <li>% of spoil lorries with covers</li> <li>Action taken for uncovered vehicles</li> </ul>	Y M M W M M M M	Lab report analyses  Field Visit  Document  Field Visit  Document				Air quality is being monitored in a year. The CICO thins that April/May is the hottest time of Bangladesh. Construction work is being implemented as full swing. So Air quality monitoring in this period may be regarded as the best sampling period and representative sampling for a year.
19.	Noise	<ul style="list-style-type: none"> <li>Notify nearby population prior to any typical noise events</li> <li>Ensure construction activities do not generate unacceptably high level of noise</li> <li>Restrict working to daylight hours</li> <li>Locate noisy equipment / facilities away from sensitive receptors</li> <li>Provide noise barriers around CC block casting machine.</li> <li>Provide ear plugs and muffs to workers at high noise area</li> </ul>	1 M W W	Field visit				

SI No.	Activities/ Aspects	Actions to be taken / Inspection items	Monitoring Frequency (1,D,W,M,Y*)	Means of monitoring	Compliant(Y/N) Repeating on- compliance(R)			Remarks
					Y	N	R	
		<ul style="list-style-type: none"> <li>Regularly monitor noise level at CC block plants and surrounding communities.</li> </ul>						
20.	Monitoring of Noise Quality	<ul style="list-style-type: none"> <li>Condition of noise from vehicles/equipment (subjective judgment by environmentalist)</li> <li>Warnings given by environmentalist</li> <li>Number of noise related complains</li> <li>Actions taken to resolve.</li> <li>Check use of ear plugs/PPEs by workers</li> </ul>	M  M W W	Field visit  Document				Noise level is being monitored as bi-monthly (twice in a month) at all CC block yard, construction sites and also nearest community of working sites/CC block manufacturing yards and kept record accordingly. The Environmental Specialist team of PMU, DDGS&PMS consultant and third party M&E consultant check the noise level and also verified the Noise level records in each of their visit.
21	Monitoring of Soil Quality	<ul style="list-style-type: none"> <li>Performance of soil quality tests at selected sites (borrow areas, spill sites) for parameters as organic matter, N, P, K, pH, Salinity, S and Zn.</li> </ul>	Y					
22	Monitoring of Drinking Water Quality	<ul style="list-style-type: none"> <li>Performance of analyses on drinking water for:</li> <li>Arsenic,</li> <li>Iron,</li> <li>Chloride and</li> <li>Total as well as faecal coliform bacteria.</li> </ul>	Y	Lab report				
23	Monitoring of Surface Water Quality	<ul style="list-style-type: none"> <li>Performance of analyses on surface water (river, khal, beel and pond) for: pH, TDS, DO, BOD, EC/Salinity and Turbidity.</li> </ul>						
24.	Flora (tree) and Fauna	<ul style="list-style-type: none"> <li>Agreeing with local authorities on tree felling.</li> <li>Document trees / area of trees.</li> <li>Avoid/prevent un-necessary tree vegetation cutting and clearing.</li> <li>Re-vegetate disturbed construction and ancillary site surfaces.</li> </ul>						

SI No.	Activities/ Aspects	Actions to be taken / Inspection items	Monitoring Frequency (1,D,W,M,Y*)	Means of monitoring	Compliant(Y/N) Repeating on- compliance(R)			Remarks
					Y	N	R	
		<ul style="list-style-type: none"> <li>Prevent disturbance of animals</li> <li>Ensuring sufficient free flow in the construction work for fish migration</li> </ul>						
25.	Water and Hydrology	<ul style="list-style-type: none"> <li>Preventing waste, soil, etc. entering in the water system by waste collection, re-vegetation and dust suppression etc.</li> <li>Insure proper drainage of working areas e.g. perimeters lines must be provided with open shallow drains</li> </ul>	M  M	Field visit				
26.	Deployment Chinese EHS Manager and Local EHS Officer	<ul style="list-style-type: none"> <li>Employ one full-time</li> <li>Number of days worked</li> <li>Number of full inspections &amp; partial inspections</li> <li>Reports to project management</li> </ul>	1  M	Document ditto				
27	Complaints on health safety, Environmental hazards and GRM	<ul style="list-style-type: none"> <li>Provide <b>COMPLAIN BOX</b> in CC block casting yard</li> <li>Grievance Redress Mechanism will be established.</li> <li>Complaints received from the public or other stake holders will be registered and recorded and be brought to the attention of the Site Engineer.</li> <li>All environmental incidents occurring on the site will be recorded and be brought to the attention of the Site Engineer.</li> <li>Action will be taken within 7 working days.</li> </ul>	1  W  W  M	Document				
28	Reporting and Documentation	<ul style="list-style-type: none"> <li>The following records will be kept at site:</li> <li>Environmental Monitoring Results</li> <li>EIA report;</li> <li>Updated C-ESMP;</li> <li>Updated EHS risk assessment Report;</li> <li>Translated (Chinese &amp; Bangla) EHS risk assessment Report;</li> <li>EHS registers (Compliance and Non-Compliance registers);</li> </ul>	M	Document				

SI No.	Activities/ Aspects	Actions to be taken / Inspection items	Monitoring Frequency (1,D,W,M,Y*)	Means of monitoring	Compliant(Y/N) Repeating on- compliance(R)			Remarks
					Y	N	R	
		<ul style="list-style-type: none"> <li>• Accident register;</li> <li>• Waste management/disposal register;</li> <li>• Noise level measurement register;</li> <li>• Toolbox/training register;</li> <li>• Complaints Register;</li> <li>• Monitoring Checklist and</li> <li>• Environmental (Air/Soil/Water) quality monitoring/tests result.</li> <li>• Monthly Complaints resolved Reports</li> </ul>						
29	Public Disclosure and consultation	<ul style="list-style-type: none"> <li>• Discussion meetings amongst stakeholders shall be organized by the contractor before commencement of major physical works of the project</li> <li>• Conduct public consultation as necessary during project implementation</li> <li>• Disclose the relevant project documents to local community</li> <li>• Establish rapport with community to liaise with community</li> <li>• Avoid religious conflict</li> </ul>						
30	Labour influx	<ul style="list-style-type: none"> <li>• Appoint local labor</li> <li>• Provide required facilities</li> <li>• Assure required wage</li> <li>• Provide leave according their demand</li> <li>• Provide required PPE</li> <li>• Follow labour rule</li> <li>• Assure rest room</li> <li>• Provide FAF</li> <li>• Allow to pray</li> <li>• Always respect their norms and values</li> </ul>						
31	Traffic management/Communi	<ul style="list-style-type: none"> <li>• Secure safety and amenity of road users and the public;</li> </ul>	W	Visual observation				

SI No.	Activities/ Aspects	Actions to be taken / Inspection items	Monitoring Frequency (1,D,W,M,Y*)	Means of monitoring	Compliant(Y/N) Repeating on- compliance(R)			Remarks
					Y	N	R	
	cation	<ul style="list-style-type: none"> <li>• Provide proper access to local communities;</li> <li>• Project identification, including project information and site signage;</li> <li>• Traffic and road user delay and inconvenience management;</li> <li>• Erect speed limit signage;</li> <li>• Traffic transfer (switch) arrangements and procedures;</li> <li>• Establish Traffic and Safety Management Responsibilities;</li> <li>• Provide separation between the public and the works.</li> <li>• Provide safety to both construction crews and the public;</li> <li>• Minimizing disruption during peak traffic periods;</li> <li>• Providing traffic control to avoid traffic conflicts and minimize delays;</li> <li>• Reduce potential distraction of road users;</li> <li>• Community consultation and notification;</li> <li>• Avoiding the hazardous movements;</li> <li>• The minimum width specified by the road authority,</li> <li>• Kept well maintained while in operation;</li> <li>• Regular maintaining the vehicle,</li> <li>• Avoid vehicle movement during peak period.</li> </ul>						
32	Tool-box talk	<ul style="list-style-type: none"> <li>• Frequent uses of required PPE</li> <li>• Health Safety</li> <li>• Follow cautionary Sign-board</li> <li>• Safe driving/operation</li> <li>• Follow speed limit</li> <li>• Follow Safety Procedures</li> <li>• Careful to hot work</li> </ul>	M	Visit				

SI No.	Activities/ Aspects	Actions to be taken / Inspection items	Monitoring Frequency (1,D,W,M,Y*)	Means of monitoring	Compliant(Y/N) Repeating on- compliance(R)			Remarks
					Y	N	R	
		<ul style="list-style-type: none"> <li>• Use harness during work at height</li> <li>• Able to operate Fire-extinguisher</li> <li>• Follow electrical safety</li> <li>• Use of Pedestrian</li> <li>• Follow signal man and warning</li> </ul>						
33	GRM	<ul style="list-style-type: none"> <li>• Establish GRM for local community and notify local community about GRM</li> <li>• Address complaints by GRC</li> <li>• Timely resolution of the complaint by GRC</li> <li>• Facilitate unresolved issues to PD</li> </ul>	M M					





SI No.	Activities/ Aspects	Actions to be taken / Inspection items	Monitoring Frequency (1,D,W,M,Y*)	Means of monitoring	Compliant(Y/N) Repeating on- compliance(R)			Remarks
		<ul style="list-style-type: none"> <li>• Training on driving safety at regular interval</li> <li>• Rise the wire up to enough height before starting the work</li> <li>• Check the physical condition of compaction vehicle</li> <li>• Check the physical condition of truck regularly</li> <li>• Conduct the toolbox talk before starting the work</li> <li>• Training on driving safety at regular interval</li> <li>• Check the physical condition of truck regularly</li> <li>• Conduct the toolbox talk before starting the work</li> <li>• Training on driving safety at regular interval</li> </ul>						
02.	Borrow material	<ul style="list-style-type: none"> <li>• Agreeing on borrow area</li> <li>• Document borrow area</li> <li>• Perform soil analyses on borrow materials when contamination is expected</li> <li>• Prevention of erosion/dust forming</li> <li>• Borrow area excavation complying with distance from the embankment as per the Technical Specifications</li> <li>• No Tress-pass line fixed with bamboo poles</li> <li>• Check the physical condition of excavator regularly</li> <li>• Conduct toolbox talk before starting the work</li> <li>• Training on driving safety at regular interval</li> <li>• Check the physical condition of truck regularly</li> </ul>	<p>1</p> <p>1</p> <p>1</p> <p>W</p> <p>1</p> <p>1</p>	<p>Document</p> <p>Lab report</p> <p>Field visit</p>				
03	Erosion	<ul style="list-style-type: none"> <li>• Side slope of the embankment to be properly cladded with clay soil and turfing shall be done as per design</li> <li>• Record cladding material and corresponding area of side slopes</li> </ul>	1	Field visit				

SI No.	Activities/ Aspects	Actions to be taken / Inspection items	Monitoring Frequency (1,D,W,M,Y*)	Means of monitoring	Compliant(Y/N) Repeating on- compliance(R)			Remarks
		<ul style="list-style-type: none"> <li>Record % area on slopes not cladded</li> </ul>						
04.	Training	<ul style="list-style-type: none"> <li>Environmental training on EMP will be arranged for Construction Supervisors, Foreman, Plant operators, Drivers.</li> <li>Monitor number of new workers receiving OHS training</li> <li>Monitor number workers receiving training, dates of training</li> </ul>	M	Document				
05.	Occupational Health and Safety	<ul style="list-style-type: none"> <li>Development of Health and Safety Plan including emergency procedures</li> <li>Train all staff in health and safety</li> <li>Provision of HIV, including STI (sexually transmitted infections) information, education and communication.</li> <li>Provision of PPE and ensuring their use (% of workers using full PPE, partial)</li> <li>Provision and use of life jacket during visiting campsite/work site by boat (number of life jacket available, number of people on board of boat)</li> <li>Installation of first aid facilities at work site and camps with adequate stock</li> <li>Provide sanitation facilities where needed (Number of users/facility, conditions)</li> <li>Provision of safe drinking water to work force (tube-well water, bottled water or pond water)</li> <li>Proper signalling of work areas</li> <li>Health screening of each worker (and every new worker) with proper documentation</li> <li>Tool box talk is conducted everyday</li> <li>Site plan is reviewed by the environmental manager of contractor before commencement of the work.</li> </ul>	<p>1</p> <p>6M</p> <p>1</p> <p>M</p> <p>M</p> <p>1</p> <p>1</p> <p>W</p> <p>M</p> <p>M</p> <p>D</p> <p>Y</p>	<p>Document</p> <p>Document</p> <p>Field visit</p> <p>Ditto</p>				

SI No.	Activities/ Aspects	Actions to be taken / Inspection items	Monitoring Frequency (1,D,W,M,Y*)	Means of monitoring	Compliant(Y/N) Repeating on- compliance(R)			Remarks
06.	Public Health and Safety	<ul style="list-style-type: none"> <li>Notification of the public adjacent to the construction areas</li> <li>Installation of dedicated pathways for pedestrians</li> <li>Proper signalling of work areas</li> <li>Limitation of construction vehicles at public roads during peak hours.</li> <li>The temporary traffic detours in settlement areas will be kept free of dust by frequent application of water.</li> <li>Construction activities will be undertaken according to during daylight working hours between the hours of 07:00 – 17:00 on weekdays.</li> <li>Minimize dust by wetting pedestrian pathways</li> <li>Inform GRM</li> </ul>	<p>M</p> <p>Y</p> <p>M</p> <p>M</p> <p>W</p> <p>W</p> <p>D</p> <p>M</p>	Field visit				
07.	Solid Waste Management	<ul style="list-style-type: none"> <li>Ensuring collection, segregation and disposal of solid wastes within the construction camps and work areas</li> <li>Taking measure to collect and store inorganic wastes in a safe place within the household and organic wastes cleared on daily basis to waste collector.</li> <li>Establish systems for waste collection, transportation and disposal systems at approved disposal sites.</li> <li>Proper collection, reuse/recycle and disposal of construction and demolition waste.</li> <li>Collect and store industrial wastes such as waste oils and chemicals, waste parts and waste materials at the designated temporally waste storage established at each work site and CC</li> </ul>	<p>M</p> <p>M</p> <p>1</p> <p>M</p>	Fieldvisit  Document				

SI No.	Activities/ Aspects	Actions to be taken / Inspection items	Monitoring Frequency (1,D,W,M,Y*)	Means of monitoring	Compliant(Y/N) Repeating on- compliance(R)			Remarks
		block plant, and treat and dispose regularly through external waste vendors.						
08.	Air	<ul style="list-style-type: none"> <li>Regular maintenance of vehicles</li> <li>Covering or wetting of dusty materials</li> <li>Dust suppression by wetting surfaces</li> <li>Impose speed limits</li> <li>Re-vegetate bare surfaces soonest</li> </ul>	M M W W M	Fieldvisit				
09.	Monitoring of Air Quality	<ul style="list-style-type: none"> <li>Performance of air quality tests at selected sensitive sites for parameters SPM2.5/10 during working hours.</li> <li>Number of working blowers</li> <li>Number of watering per day</li> <li>Number of complains on air quality</li> <li>Warnings given by environmentalist</li> <li>Actions taken to resolve</li> <li>Highlights of quarry dust control (covers, sprays, operational status)</li> <li>% of spoil lorries with covers</li> <li>Action taken for uncovered vehicles</li> </ul>	Y  M M W M M M M	Lab reportanalyses  Field Visit  Document  Field Visit  Document				
10.	Noise	<ul style="list-style-type: none"> <li>Notify nearby population prior to any typical noise events</li> <li>Ensure construction activities do not generate unacceptably high level of noise</li> <li>Restrict working to daylight hours</li> <li>Locate noisy equipment / facilities away from sensitive receptors</li> <li>Provide noise barriers around CC block casting machine.</li> <li>Provide ear plugs and muffs to workers at high noise area</li> <li>Regularly monitor noise level at CC block plants and surrounding communities.</li> </ul>	1  M  W W	Fieldvisit				

SI No.	Activities/ Aspects	Actions to be taken / Inspection items	Monitoring Frequency (1,D,W,M,Y*)	Means of monitoring	Compliant(Y/N) Repeating on- compliance(R)			Remarks
		<ul style="list-style-type: none"> <li>Regular hearing test for workers at high noise area (once in six months)</li> </ul>						
11.	Monitoring of Noise Quality	<ul style="list-style-type: none"> <li>Condition of noise from vehicles/equipment (subjective judgment by environmentalist)</li> <li>Warnings given by environmentalist</li> <li>Number of noise related complains</li> <li>Actions taken to resolve.</li> </ul>	M  M W W	Field visit  Document				
12.	Water and Hydrology	<ul style="list-style-type: none"> <li>Preventing waste, soil, etc. entering in the water system by waste collection, re-vegetation and dust suppression etc.</li> <li>Insure proper drainage of working areas e.g. perimeters lines must be provided with open shallow drains</li> </ul>	M  M	Fieldvisit				
13.	Monitoring of surface water quality	<ul style="list-style-type: none"> <li>Test surface water quality as per EMP (TDS, Turbidity, pH, DO, BOD, COD)</li> </ul>	Y	Lab report				
14.	Flora (tree) and Fauna	<ul style="list-style-type: none"> <li>Agreeing with local authorities on tree felling.</li> <li>Document trees / area of trees.</li> <li>Avoid/prevent un-necessary tree vegetation cutting and clearing.</li> <li>Re-vegetate disturbed construction and ancillary site surfaces.</li> <li>Prevent disturbance of animals</li> <li>Ensuring sufficient free flow in the construction work for fish migration</li> </ul>	1  1 M  1 M D	Document and Field visit				
15.	Deployment Chinese EHS Manager and Local EHS Officer	<ul style="list-style-type: none"> <li>Employ one full-time</li> <li>Number of days worked</li> <li>Number of full inspections &amp; partial inspections</li> <li>Reports to project management</li> </ul>	1  M	Document ditto				
16.	Complaints on health safety, Environmental hazards and GRM	<ul style="list-style-type: none"> <li>Grievance Redress Mechanism will be established.</li> <li>Complaints received from the public or other</li> </ul>	1  W					

SI No.	Activities/ Aspects	Actions to be taken / Inspection items	Monitoring Frequency (1,D,W,M,Y*)	Means of monitoring	Compliant(Y/N) Repeating on- compliance(R)			Remarks
		stake holders will be registered and recorded and be brought to the attention of the Site Engineer. • All environmental incidents occurring on the site will be recorded and be brought to the attention of the Site Engineer. • Action will be taken within 7 working days.	W  M	Document				
17.	Reporting and Documentation	• The following records will be kept at site: • Environmental Monitoring Results <ul style="list-style-type: none"> <li>○ Contractors self-assessment record/results</li> <li>○ Register of non-compliance</li> <li>○ Register of corrective actions</li> <li>○ Monthly Environmental Reports</li> </ul>	M	Document				
18	Public Disclosure and Consultation	• Discussion meetings amongst stakeholders shall be organized by the contractor before commencement of major physical works of the project • Conduct public consultation as necessary during project implementation • Disclose the relevant project documents to local community • Establish rapport with community to liaise with community • Avoid religious conflict						
19	Labour influx	• Appoint local labor • Provide required facilities • Assure required wage • Provide leave according their demand • Provide required PPE • Follow labour rule • Assure rest room • Provide FAF • Allow to pray						

SI No.	Activities/ Aspects	Actions to be taken / Inspection items	Monitoring Frequency (1,D,W,M,Y*)	Means of monitoring	Compliant(Y/N) Repeating on- compliance(R)			Remarks
		<ul style="list-style-type: none"> <li>• Always respect their norms and values</li> </ul>						
20	Traffic management/ Communication	<ul style="list-style-type: none"> <li>• Secure Safety and amenity of road users and the public;</li> <li>• Provide proper access to local communities;</li> <li>• Project identification, including project information and site signage;</li> <li>• Traffic and road user delay and inconvenience management;</li> <li>• Erect speed limit signage;</li> <li>• Traffic transfer (switch) arrangements and procedures;</li> <li>• Establish Traffic and Safety Management Responsibilities;</li> <li>• Provide separation between the public and the works.</li> <li>• Provide safety to both construction crews and the public;</li> <li>• Minimizing disruption during peak traffic periods;</li> <li>• Providing traffic control to avoid traffic conflicts and minimize delays;</li> <li>• Reduce potential distraction of road users;</li> <li>• Community consultation and notification;</li> <li>• Avoiding the hazardous movements;</li> <li>• The minimum width specified by the road authority,</li> <li>• Kept well maintained while in operation;</li> <li>• Regular maintaining the vehicle,</li> <li>• Avoid vehicle movement during peak period.</li> </ul>	W	Visual observation				
21	Tool-box talk	<ul style="list-style-type: none"> <li>• Frequent uses of required PPE</li> <li>• Carefully loading the debris</li> <li>• Safe way for workers</li> </ul>	D	Visit				

### Annex-5: Monitoring Checklist for the bank and slope protection works

<p><b>Name of the Project: Coastal Embankment Improvement Project, Phase-1</b></p> <p><b>Contract Package No: W-02</b></p> <p><b>Name of Polder : 40/2</b></p>	<p><b>Name of Activity: The bank and slope protection works Location:</b></p> <p><b>Date of Inspection:</b></p> <p><b>Inspected by:</b></p>
--	---

SI No.	Activities/ Aspects	Actions to be taken / Inspection items	Monitoring Frequency (1,D,W,M,Y*)	Means of monitoring	Compliant(Y/N) Repeating on- compliance(R)			Remarks
01.	The bank and slope protection works	<ul style="list-style-type: none"> <li>• Spilling of earth material in surface water will be avoided.</li> <li>• Turfing will be applied to prevent erosion.</li> <li>• Proper drainage provision will be kept to avoid formation of rain cuts due to surface run off.</li> </ul>	W  W  M	Field visit				
02.	Manufacture of pre-cast CC Blocks	<ul style="list-style-type: none"> <li>• Provide noise control barrier around the plant area as possible</li> <li>• Make a closed chamber for plant operator</li> <li>• Periodic hearing check for the exposed workers</li> <li>• Shifting duty for the noise exposed areas</li> <li>• Spray water at certain intervals in the plant area</li> <li>• Wet and clean the aggregate before using</li> <li>• Cover/wet dusty parts or materials</li> <li>• No operation without the screen or barrier provided with the machine</li> <li>• Conduct toolbox talk regularly</li> <li>• Establish and practice the safe operation procedure</li> <li>• Regular checking of Automatic CC plant</li> </ul>		Field visit				



SI No.	Activities/ Aspects	Actions to be taken / Inspection items	Monitoring Frequency (1,D,W,M,Y*)	Means of monitoring	Compliant(Y/N) Repeating on- compliance(R)			Remarks
		<ul style="list-style-type: none"> <li>• Check electric switch, fuel and all types connection line during off and on the plant.</li> <li>• Reserve the key with the designated person only</li> <li>• Conduct proper repair, whenever required</li> <li>• Properly cover the conveyer system</li> <li>• Check the roller system before and after the work every day or at regular intervals</li> <li>• Regular check on the belt systems</li> <li>• Regular check on conveyer systems</li> <li>• Make protective fence or moveable barrier around the hopper hole</li> <li>• Regular check on weir system</li> <li>• Proper maintenance of hopper</li> <li>• Change the weir immediate when need</li> <li>• Check the lock before use</li> <li>• Regular check and maintenance of hopper before loading</li> <li>• Use ear plug and ear muff before starting the work</li> <li>• Set the equipment at one open site away from the plant area, curing area, living area</li> <li>• Use ear plug and ear muff before starting the concrete core cutting</li> <li>• Set the core cutting equipment at one open site away from the plant area, curing area, living area</li> <li>• Provide continuous water flow during cutting operation by pipe</li> <li>• Spray water at during intervals at stockpile areas</li> <li>• Wet/cover the sand or aggregate storage at stockpile areas</li> <li>• Make a wall around the storage area. The height</li> </ul>						

SI No.	Activities/ Aspects	Actions to be taken / Inspection items	Monitoring Frequency (1,D,W,M,Y*)	Means of monitoring	Compliant(Y/N) Repeating on- compliance(R)			Remarks
		<p>will be related to the height of stockpiling</p> <ul style="list-style-type: none"> <li>• Make stockpile area as no entry zone</li> <li>• Provide cautionary signboard at stockpile areas</li> <li>• Demarcate the CC block stacking area</li> <li>• Provide cautionary signboard at CC block stacking areas</li> <li>• Make CC block stacking area as no entry zone</li> <li>• Regular check the switch board and weir system</li> <li>• Turn off the main switch board</li> <li>• Use the fire-extinguisher and sand as required</li> <li>• Regular check the switch board and weir system</li> <li>• Turn off the main switch board</li> <li>• Use the fire-extinguisher and sand as required</li> <li>• Rise the wire system up or underground conduit system should be established</li> <li>• All joint will be insulated</li> <li>• Closed all the switch board properly. Only responsible person will check at regular intervals</li> <li>• Provide the gas mask properly during welding</li> <li>• Provide special cloth for welding</li> <li>• Provide the eye protective welding glass</li> <li>• Maintain a minimum distance (6.1 m) from the fuel gas cylinder</li> <li>• Check the hose pipe system regularly</li> <li>• Workers will be equipped with proper PPE.</li> <li>• Signals will be installed to indicate the entry and exits and movement of vehicles in the work area.</li> <li>• Care during use of forklifts to transfer CC Blocks</li> <li>• Manufacturing only can take place at night within proper environmental protective measurement.</li> <li>• Stacks with sand will be covered or wetted.</li> </ul>						

SI No.	Activities/ Aspects	Actions to be taken / Inspection items	Monitoring Frequency (1,D,W,M,Y*)	Means of monitoring	Compliant(Y/N) Repeating on- compliance(R)			Remarks
		<ul style="list-style-type: none"> <li>• Use hand gloves during operation</li> <li>• Check the plate joint regularly, about its stability</li> <li>• Spray water during intervals</li> <li>• Wet the sand or aggregate</li> <li>• Worker's standing area should maintain certain distance from the loading and unloading area</li> <li>• Checking silo surface for avoidance leakage</li> <li>• Avoid excess load in silo</li> </ul>						
03.	Training	<ul style="list-style-type: none"> <li>• Environmental training on EMP will be arranged for Construction Supervisors, Foreman, Plant operators, Drivers.</li> <li>• Monitor number of new workers receiving OHS training</li> <li>• Monitor number workers receiving training, dates of training</li> </ul>	M	Document				
04.	Occupational Health and Safety	<ul style="list-style-type: none"> <li>• Development of Health and Safety Plan including emergency procedures</li> <li>• Train all staff in health and safety</li> <li>• Provision of HIV, including STI (sexually transmitted infections) information, education and communication.</li> <li>• Provision of PPE and ensuring their use (% of workers using full PPE, partial)</li> <li>• Provision and use of life jacket during visiting campsite/work site by boat (number of life jacket available, number of people on board of boat)</li> <li>• Installation of first aid facilities at work site and camps with adequate stock</li> <li>• Provide sanitation facilities where needed (Number of users/facility, conditions)</li> <li>• Provision of safe drinking water to work force</li> </ul>	1 6M 1 M M 1 1 W	Document Document Field visit Ditto				

SI No.	Activities/ Aspects	Actions to be taken / Inspection items	Monitoring Frequency (1,D,W,M,Y*)	Means of monitoring	Compliant(Y/N) Repeating on- compliance(R)			Remarks
		(tube-well water, bottled water or pond water) <ul style="list-style-type: none"> <li>• Proper signalling of work areas</li> <li>• Health screening of each worker (and every new worker) with proper documentation</li> <li>• Tool box talk is conducted everyday</li> <li>• Site plan is reviewed by the environmental manager of contractor before commencement of the work.</li> </ul>	M M D Y					
05.	Public Health and Safety	<ul style="list-style-type: none"> <li>• Notification of the public adjacent to the construction areas</li> <li>• Installation of dedicated pathways for pedestrians</li> <li>• Proper signalling of work areas</li> <li>• Limitation of construction vehicles at public roads during peak hours.</li> <li>• The temporary traffic detours in settlement areas will be kept free of dust by frequent application of water.</li> <li>• Construction activities will be undertaken according to during daylight working hours between the hours of 07:00 – 17:00 on weekdays.</li> <li>• Minimize dust by wetting pedestrian pathways</li> <li>• Inform GRM</li> </ul>	M Y M M W W D M	Field visit				
06.	Solid Waste Management	<ul style="list-style-type: none"> <li>• Ensuring collection and disposal of solid wastes within the construction camps and work areas</li> <li>• Taking measure to collect and store inorganic wastes in a safe place within the household and organic wastes cleared on daily basis to waste collector. (quantity/ number and size of bins)</li> <li>• Establish measures for Waste collection, transportation and disposal systems at approved disposal sites. (register disposal time and means)</li> </ul>	M M 1 M	Field visit   Document				

SI No.	Activities/ Aspects	Actions to be taken / Inspection items	Monitoring Frequency (1,D,W,M,Y*)	Means of monitoring	Compliant(Y/N) Repeating on- compliance(R)			Remarks
		<ul style="list-style-type: none"> <li>Disposal of construction and demolition waste. (quantity, location, by whom)</li> </ul>						
07.	Air	<ul style="list-style-type: none"> <li>Regular maintenance of vehicles</li> <li>Covering or wetting of dusty materials</li> <li>Dust suppression by wetting surfaces</li> <li>Impose speed limits</li> <li>Re-vegetate bare surfaces soonest</li> </ul>	M M W W M	Fieldvisit				
08.	Monitoring of Air Quality	<ul style="list-style-type: none"> <li>Performance of air quality tests at selected sensitive sites for parameters SPM2.5/10 during working hours.</li> <li>Number of working blowers</li> <li>Number of watering per day</li> <li>Number of complains on air quality</li> <li>Warnings given by environmentalist</li> <li>Actions taken to resolve</li> <li>Highlights of quarry dust control (covers, sprays, operational status)</li> <li>% of spoil lorries with covers</li> <li>Action taken for uncovered vehicles</li> </ul>	Y  M M W M M M M M	Lab report analyses  Field Visit  Document  Field Visit  Document				
09.	Noise	<ul style="list-style-type: none"> <li>Notify nearby population prior to any typical noise events</li> <li>Ensure construction activities do not generate unacceptably high level of noise</li> <li>Restrict working to daylight hours</li> <li>Locate noisy equipment/ facilities away from sensitive receptors</li> </ul>	1  M W W	Field visit				
10.	Monitoring of Noise Quality	<ul style="list-style-type: none"> <li>Condition of noise from vehicles/equipment (subjective judgment by environmentalist)</li> <li>Warnings given by environmentalist</li> <li>Number of noise related complains</li> <li>Actions taken to resolve.</li> </ul>	M  M W	Field visit  Document				

SI No.	Activities/ Aspects	Actions to be taken / Inspection items	Monitoring Frequency (1,D,W,M,Y*)	Means of monitoring	Compliant(Y/N) Repeating on- compliance(R)			Remarks
			W					
11.	Water and Hydrology	<ul style="list-style-type: none"> <li>Preventing waste, soil, etc. entering in the water system by waste collection, re-vegetation and dust suppression etc.</li> <li>Insure proper drainage of working areas e.g. perimeters lines must be provided with open shallow drains</li> </ul>	M  M	Field visit				
12.	Flora (tree) and Fauna	<ul style="list-style-type: none"> <li>Agreeing with local authorities on tree felling.</li> <li>Document trees/area of trees.</li> <li>Avoid/prevent un-necessary tree vegetation cutting and clearing.</li> <li>Re-vegetate disturbed construction and ancillary site surfaces.</li> <li>Prevent disturbance of animals</li> <li>Ensuring sufficient free flow of water in the construction work areas for fish migration</li> </ul>	1 1 M  1  M	Document and Field visit				
13.	Deployment Chinese EHS Manager and Local EHS Officer	<ul style="list-style-type: none"> <li>Employ one full-time</li> <li>Number of days worked</li> <li>Number of full inspections &amp; partial inspections</li> <li>Reports to project management</li> </ul>	1  M	Document ditto				
14.	Complaints on health safety, Environmental hazards and GRM	<ul style="list-style-type: none"> <li>Grievance Redress Mechanism will be established.</li> <li>Complaints received from the public or other stake holders will be registered and recorded and be brought to the attention of the Site Engineer.</li> <li>All environmental incidents occurring on the site will be recorded and be brought to the attention of the Site Engineer.</li> <li>Action will be taken within 7 working days.</li> </ul>	1  W  W  M	Document				
15.	Reporting and Documentation	<ul style="list-style-type: none"> <li>The following records will be kept at site:</li> <li>Environmental Monitoring Results                             <ul style="list-style-type: none"> <li>Contractors self-assessment record/results</li> </ul> </li> </ul>	M	Document				

SI No.	Activities/ Aspects	Actions to be taken / Inspection items	Monitoring Frequency (1,D,W,M,Y*)	Means of monitoring	Compliant(Y/N) Repeating on- compliance(R)			Remarks
		<ul style="list-style-type: none"> <li>○ Register of non-compliance</li> <li>○ Register of corrective actions</li> <li>○ Monthly Environmental Reports</li> </ul>						
16	Public Disclosure and Consultation	<ul style="list-style-type: none"> <li>● Discussion meetings amongst stakeholders shall be organized by the contractor before commencement of major physical works of the project</li> <li>● Conduct public consultation as necessary during project implementation</li> <li>● Disclose the relevant project documents to local community</li> <li>● Establish rapport with community to liaise with community</li> <li>● Avoid religious conflict</li> </ul>						
17	Labour influx	<ul style="list-style-type: none"> <li>● Appoint local labor</li> <li>● Provide required facilities</li> <li>● Assure required wage</li> <li>● Provide leave according their demand</li> <li>● Provide required PPE</li> <li>● Follow labour rule</li> <li>● Assure rest room</li> <li>● Provide FAF</li> <li>● Allow to pray</li> <li>● Always respect their norms and values</li> </ul>						
18	Traffic management/communication	<ul style="list-style-type: none"> <li>● Secure Safety and amenity of road users and the public;</li> <li>● Provide proper access to local community;</li> <li>● Project identification, including project information and site signage;</li> <li>● Traffic and road user delay and inconvenience</li> </ul>	W	Visual observation				

SI No.	Activities/ Aspects	Actions to be taken / Inspection items	Monitoring Frequency (1,D,W,M,Y*)	Means of monitoring	Compliant(Y/N) Repeating on- compliance(R)			Remarks
		management; • Erect speed limit signage; • Establish Traffic transfer (switch) arrangements and procedures; • Traffic and Safety Management Responsibilities; • Provide separation between the public and the works. • Provide safety to both construction crews and the public; • Minimizing disruption during peak traffic periods; • Providing traffic control to avoid traffic conflicts and minimize delays; • Reduce potential distraction of road users; • Community consultation and notification; • Avoiding the hazardous movements; • The minimum width specified by the road authority, • Kept well maintained while in operation; • Regular maintaining the vehicle, • Avoid vehicle movement during peak period.						
19	Tool-box talk	• Frequent uses of required PPE • Carefully loading the debris • Safe way for workers	D	Visit				



## Annex-6: Monitoring Checklist for Construction and demolishing of drainage sluices/flushing sluices

<p><b>Name of the Project: Coastal Embankment Improvement Project, Phase-1</b></p> <p><b>Contract Package No: W-02</b></p> <p><b>Name of Polder : 40/2</b></p>	<p><b>Name of Activity: Construction and Demolishing of drainage sluices/flushing sluices</b></p> <p><b>Location:</b></p> <p><b>Date of Inspection:</b></p> <p><b>Inspected by:</b></p>
--	---

SI No.	Activities/ Aspects	Actions to be taken / Inspection items	Monitoring Frequency (1,D,W,M,Y*)	Means of monitoring	Compliant(Y/N) Repeating on- compliance(R)			Remarks
01.	Construction and demolishing of drainage sluices, flushing sluices and inlets	<ul style="list-style-type: none"> <li>• Check properties of soil as per the guideline of DDCS&amp;PMS consultant of cofferdam/ring bundh</li> <li>• Make arrangement for emergency work or some immediate action in case of cofferdam failure</li> <li>• Make diversion road or dedicated path way for local pedestrian</li> <li>• Provide PPE to workers</li> <li>• Separate the worker's standing area during hammering</li> <li>• Check the U-clamp and all joint regularly</li> <li>• Maintain the uniform velocity of hammer</li> <li>• Avoid the certain falling of hammer</li> <li>• Avoid hammering during pouring of sand</li> <li>• Separate the other workers during removing the casing</li> <li>• Check the all joint regularly at start and end of the work</li> <li>• Replace the joint at regular intervals</li> <li>• Check the all weir regularly at start and end of</li> </ul>	<p>W</p> <p>1</p> <p>Y</p> <p>W</p> <p>W</p> <p>W</p> <p>M</p>	<p>Document</p> <p>Fieldvisit</p>				

SI No.	Activities/ Aspects	Actions to be taken / Inspection items	Monitoring Frequency (1,D,W,M,Y*)	Means of monitoring	Compliant(Y/N) Repeating on- compliance(R)			Remarks
		<p>the work</p> <ul style="list-style-type: none"> <li>• Replace the weir at regular intervals</li> <li>• Regular check of all parts of piling system</li> <li>• Provide ear plug and ear muff during piling</li> <li>• Periodic hearing check of labours engaged in piling</li> <li>• Use the wet sand as per required amount during piling</li> <li>• Toolbox talk conduct at the beginning of piling work</li> <li>• Use paved workshop for rod cutting</li> <li>• Collect the residual materials in a specified place rod cutting</li> <li>• Provide gas musk to the rod cutting workers</li> <li>• Set the cutting area away from the receptor as possible</li> <li>• Provide ear plug/muff to the operator and the surroundings</li> <li>• Conduct toolbox talk at the beginning of the rod cutting work</li> <li>• Check the circuit system before starting the welding</li> <li>• Turn off the main switch, then use the fire extinguisher</li> <li>• Use the protective cover of the rod cutting machine</li> <li>• Conduct toolbox talk at the beginning of the rod cutting work</li> <li>• Conduct toolbox talk at the beginning of the rod bending work</li> <li>• Provide the gas mask properly during welding</li> <li>• Provide special cloth for welding</li> </ul>	1					

SI No.	Activities/ Aspects	Actions to be taken / Inspection items	Monitoring Frequency (1,D,W,M,Y*)	Means of monitoring	Compliant(Y/N) Repeating on- compliance(R)			Remarks
		<ul style="list-style-type: none"> <li>• Provide the eye protective welding glass</li> <li>• Provide the protective cloth to workers for welding works</li> <li>• Maintain a minimum welding area distance (6.1 m) from the fuel gas cylinder</li> <li>• Check the pipe system of welding regularly</li> <li>• Conduct toolbox talk at the beginning of the RCC work</li> <li>• Provide PPE to all workers</li> <li>• Spray water at material stock piling area at regular intervals</li> <li>• Wet/cover the sand or aggregate storage</li> <li>• Make a wall around the storage area. The height will be related to the height of stockpiling</li> <li>• Make the stock piling area as no entry zone</li> <li>• Provide all cautionary signals and signboard/signage</li> <li>• Maintain the shuttering space as per design</li> <li>• Support should be placed in level ground for shuttering</li> <li>• Periodic check of generator</li> <li>• Closing by noise protective board of generator</li> <li>• Set the generator away from the sensitive receptors</li> <li>• Use filter media to suck the emitted gas from generator</li> <li>• Rise the outlet of generator above the breathing zone</li> <li>• Provide fire-extinguisher nearby the generator area</li> <li>• Make a stable platform with ladder</li> <li>• No workers will be allowed to walk over pipe</li> </ul>						

SI No.	Activities/ Aspects	Actions to be taken / Inspection items	Monitoring Frequency (1,D,W,M,Y*)	Means of monitoring	Compliant(Y/N) Repeating on- compliance(R)			Remarks
		<ul style="list-style-type: none"> <li>• Provide safety belt to the workers who work above 2 m height</li> <li>• Put a net system with sufficient capacity to catch the fallen object</li> <li>• Only the pile to be driven in day time</li> <li>• Before starting the pile driving, notify the adjacent receptors about the noisy activity</li> <li>• Check the strength and load bearing capacity before driving of sheet pile</li> <li>• Gradually increase the load value, not suddenly for sheet piling</li> <li>• Check the equipment for sheet piling work before use</li> <li>• Follow the manual from manufacturer of sheet piling equipment</li> <li>• Conduct toolbox talk before starting the painting work</li> <li>• For work in height, make a stable platform with railing and ladder for painting work</li> <li>• Provide solid demarcation around the excavation</li> <li>• Establish sufficient sign/signalling that can be visible in night around excavation area</li> <li>• Erect light reflective signboard around excavation area</li> <li>• Set and check the stability of excavator after certain interval during work</li> <li>• Make the demarcation around the excavation</li> <li>• Erect the cautionary signs and signals around excavation</li> <li>• Conduct the toolbox talk to grow the awareness about hazard of excavation</li> </ul>						

SI No.	Activities/ Aspects	Actions to be taken / Inspection items	Monitoring Frequency (1,D,W,M,Y*)	Means of monitoring	Compliant(Y/N) Repeating on- compliance(R)			Remarks
		<ul style="list-style-type: none"> <li>• Conduct regular toolbox talk before starting the concrete casting work</li> <li>• Workers engaged in concrete work should use PPE</li> <li>• Ensure safe pathway of workers for concrete casting</li> <li>• Demolishing debris of sluices and inlets will be disposed of at a site approved by the Engineer.</li> <li>• Before starting the construction activities of drainage sluices, ring bundh and diversion channel will be constructed and a dewatering system will be installed in order to work in dry conditions.</li> <li>• Disposal of excess soil will be done with no objection from local authority.</li> <li>• No waste water from concrete mixing will be disposed of directly to the surface water.</li> <li>• Prior to every monsoon season all the temporary and permanent drainage structures under construction will be made free from debris.</li> <li>• Remove all materials and equipment from work site after completion of works.</li> </ul>						
02.	Training	<ul style="list-style-type: none"> <li>• Environmental training on EMP will be arranged for Construction Supervisors, Foreman, Plant operators, Drivers.</li> <li>• Monitor number of new workers receiving OHS training</li> <li>• Monitor number workers receiving training, dates of training</li> </ul>	M	Document				
	Electrical safety	<ul style="list-style-type: none"> <li>• Clearly visible notification on the safe use of electrical appliances</li> </ul>						

SI No.	Activities/ Aspects	Actions to be taken / Inspection items	Monitoring Frequency (1,D,W,M,Y*)	Means of monitoring	Compliant(Y/N) Repeating on- compliance(R)			Remarks
		<ul style="list-style-type: none"> <li>• Check all wirings to prevent any accident, fire due to short circuit</li> <li>• Rise the wire system up or underground conduit system should be established</li> <li>• Regular check the switch board and wire system</li> <li>• Close all the switch board properly. Only responsible will check at regular intervals</li> <li>• Cover the joint by tape or other insulating materials</li> </ul>						
03.	Occupational Health and Safety	<ul style="list-style-type: none"> <li>• Development of Health and Safety Plan including emergency procedures</li> <li>• Train all staff in health and safety</li> <li>• Provision of HIV, including STI (sexually transmitted infections) information, education and communication.</li> <li>• Provision of PPE and ensuring their use (% of workers using full PPE, partial)</li> <li>• Provision and use of life jacket during visiting campsite/work site by boat (number of life jacket available, number of people on board of boat)</li> <li>• Installation of first aid facilities at work site and camps with adequate stock</li> <li>• Provide sanitation facilities where needed (Number of users/facility, conditions)</li> <li>• Provision of safe drinking water to work force (tube-well water, bottled water or pond water)</li> <li>• Proper signalling of work areas</li> <li>• Health screening of each worker (and every new worker) with proper documentation</li> <li>• Tool box talk is conducted everyday</li> <li>• Site plan is reviewed by the environmental</li> </ul>	<p>1</p> <p>6M</p> <p>1</p> <p>M</p> <p>M</p> <p>1</p> <p>1</p> <p>W</p> <p>M</p> <p>M</p> <p>D</p> <p>Y</p>	<p>Document</p> <p>Document</p> <p>Field visit</p> <p>Ditto</p>				

SI No.	Activities/ Aspects	Actions to be taken / Inspection items	Monitoring Frequency (1,D,W,M,Y*)	Means of monitoring	Compliant(Y/N) Repeating on- compliance(R)			Remarks
		manager of contractor before commencement of the work.						
04.	Public Health and Safety	<ul style="list-style-type: none"> <li>Notification of the public adjacent to the construction areas</li> <li>Installation of dedicated pathways for pedestrians</li> <li>Proper signalling of work areas</li> <li>Limitation of construction vehicles at public roads during peak hours.</li> <li>The temporary traffic detours in settlement areas will be kept free of dust by frequent application of water.</li> <li>Construction activities will be undertaken according to during daylight working hours between the hours of 07:00 – 17:00 on weekdays.</li> <li>Minimize dust by wetting pedestrian pathways</li> <li>Inform GRM</li> </ul>	<p>M</p> <p>Y</p> <p>M</p> <p>M</p> <p>W</p> <p>W</p> <p>D</p> <p>M</p>	Field visit				
05.	Solid Waste Management	<ul style="list-style-type: none"> <li>Ensuring collection and disposal of solid wastes within the construction camps and work areas</li> <li>Taking measure to collect and store inorganic wastes in a safe place within the household and organic wastes cleared on daily basis to waste collector. (quantity/ number and size of bins)</li> <li>Establish measures for Waste collection, transportation and disposal systems at approved disposal sites. (register disposal time and means)</li> <li>Disposal of construction and demolition waste. (quantity, location, by whom)</li> </ul>	<p>M</p> <p>M</p> <p>1</p> <p>M</p>	<p>Field visit</p> <p>Document</p>				
06.	Air	<ul style="list-style-type: none"> <li>Regular maintenance of vehicles</li> <li>Covering or wetting of dusty materials</li> <li>Dust suppression by wetting surfaces</li> </ul>	<p>M</p> <p>M</p> <p>W</p>	Field visit				

SI No.	Activities/ Aspects	Actions to be taken / Inspection items	Monitoring Frequency (1,D,W,M,Y*)	Means of monitoring	Compliant(Y/N) Repeating on- compliance(R)			Remarks
		<ul style="list-style-type: none"> <li>• Impose speed limits</li> <li>• Re-vegetate bare surfaces soonest</li> </ul>	W M					
07.	Monitoring of Air Quality	<ul style="list-style-type: none"> <li>• Performance of air quality tests at selected sensitive sites for parameters SPM2.5/10 during working hours.</li> <li>• Number of working blowers</li> <li>• Number of watering per day</li> <li>• Number of complains on air quality</li> <li>• Warnings given by environmentalist</li> <li>• Actions taken to resolve</li> <li>• Highlights of quarry dust control (covers, sprays, operational status)</li> <li>• % of spoil lorries with covers</li> <li>• Action taken for uncovered vehicles</li> </ul>	Y  M M W M M M M M	Lab report analyses  Field Visit  Document  Field Visit  Document				
08.	Noise	<ul style="list-style-type: none"> <li>• Notify nearby population prior to any typical noise events</li> <li>• Ensure construction activities do not generate unacceptably high level of noise</li> <li>• Restrict working to daylight hours</li> <li>• Locate noisy equipment/ facilities away from sensitive receptors</li> </ul>	1  M W W	Field visit				
09.	Monitoring of Noise Quality	<ul style="list-style-type: none"> <li>• Condition of noise from vehicles/equipment (subjective judgment by environmentalist)</li> <li>• Warnings given by environmentalist</li> <li>• Number of noise related complains</li> <li>• Actions taken to resolve.</li> </ul>	M  M W W	Field visit  Document				
10.	Water and Hydrology	<ul style="list-style-type: none"> <li>• Preventing waste, soil, etc. entering in the water system by waste collection, re-vegetation and dust suppression etc.</li> <li>• Insure proper drainage of working areas e.g. perimeters lines must be provided with open</li> </ul>	M  M	Field visit				



SI No.	Activities/ Aspects	Actions to be taken / Inspection items	Monitoring Frequency (1,D,W,M,Y*)	Means of monitoring	Compliant(Y/N) Repeating on- compliance(R)			Remarks
		shallow drains						
11.	Flora (tree) and Fauna	<ul style="list-style-type: none"> <li>• Agreeing with local authorities on tree felling.</li> <li>• Document trees/area of trees.</li> <li>• Avoid/prevent un-necessary tree vegetation cutting and clearing.</li> <li>• Re-vegetate disturbed construction and ancillary site surfaces.</li> <li>• Prevent disturbance of animals</li> <li>• Ensuring sufficient free flow of water in the construction work areas for fish migration</li> </ul>	<p>1</p> <p>1</p> <p>M</p> <p>1</p> <p>M</p>	Document and Field visit				
12.	Deployment Chinese EHS Manager and Local EHS Officer	<ul style="list-style-type: none"> <li>• Employ one full-time</li> <li>• Number of days worked</li> <li>• Number of full inspections &amp; partial inspections</li> <li>• Reports to project management</li> </ul>	<p>1</p> <p>M</p>	Document ditto				
13.	Complaints on health safety, Environmental hazards and GRM	<ul style="list-style-type: none"> <li>• Grievance Redress Mechanism will be established.</li> <li>• Complaints received from the public or other stake holders will be registered and recorded and be brought to the attention of the Site Engineer.</li> <li>• All environmental incidents occurring on the site will be recorded and be brought to the attention of the Site Engineer.</li> <li>• Action will be taken within 7 working days.</li> </ul>	<p>1</p> <p>W</p> <p>W</p> <p>M</p>	Document				
14.	Reporting and Documentation	<ul style="list-style-type: none"> <li>• The following records will be kept at site:</li> <li>• Environmental Monitoring Results                             <ul style="list-style-type: none"> <li>○ Contractors self-assessment record/results</li> <li>○ Register of non-compliance</li> <li>○ Register of corrective actions</li> <li>○ Monthly Environmental Reports</li> </ul> </li> </ul>	M	Document				
15	Public Disclosure and Consultation	<ul style="list-style-type: none"> <li>• Discussion meetings amongst stakeholders shall be organized by the contractor before commencement of major physical works of the</li> </ul>						

SI No.	Activities/ Aspects	Actions to be taken / Inspection items	Monitoring Frequency (1,D,W,M,Y*)	Means of monitoring	Compliant(Y/N) Repeating on- compliance(R)			Remarks
		project <ul style="list-style-type: none"> <li>• Conduct public consultation as necessary during project implementation</li> <li>• Disclose the relevant project documents to local community</li> <li>• Establish rapport with community to liaise with community</li> <li>• Avoid religious conflict</li> </ul>						
16	Labour influx	<ul style="list-style-type: none"> <li>• Appoint local labor</li> <li>• Provide required facilities</li> <li>• Assure required wage</li> <li>• Provide leave according their demand</li> <li>• Provide required PPE</li> <li>• Follow labour rule</li> <li>• Assure rest room</li> <li>• Provide FAF</li> <li>• Allow to pray</li> <li>• Always respect their norms and values</li> </ul>						
17	Traffic management/communication	<ul style="list-style-type: none"> <li>• Secure Safety and amenity of road users and the public;</li> <li>• Provide proper access to local communities;</li> <li>• Project identification, including project information and site signage;</li> <li>• Traffic and road user delay and inconvenience management;</li> <li>• Erect speed limit signage;</li> <li>• Traffic transfer (switch) arrangements and procedures;</li> <li>• Establish Traffic and Safety Management Responsibilities;</li> <li>• Provide separation between the public and the works.</li> </ul>	W	Visual observation				

SI No.	Activities/ Aspects	Actions to be taken / Inspection items	Monitoring Frequency (1,D,W,M,Y*)	Means of monitoring	Compliant(Y/N) Repeating on- compliance(R)			Remarks
		<ul style="list-style-type: none"> <li>• Provide safety to both construction crews and the public;</li> <li>• Minimizing disruption during peak traffic periods;</li> <li>• Providing traffic control to avoid traffic conflicts and minimize delays;</li> <li>• Reduce potential distraction of road users;</li> <li>• Community consultation and notification;</li> <li>• Avoiding the hazardous movements;</li> <li>• The minimum width specified by the road authority,</li> <li>• Kept well maintained while in operation;</li> <li>• Regular maintaining the vehicle,</li> <li>• Avoid vehicle movement during peak period.</li> </ul>						
18	Tool-box talk	<ul style="list-style-type: none"> <li>• Frequent uses of required PPE</li> <li>• Carefully loading the debris</li> <li>• Safe way for workers</li> </ul>	D	Visit				

## Annex-7: Monitoring Checklist for Re-excavation of Khal

<p><b>Name of the Project: Coastal Embankment Improvement Project, Phase-1</b></p> <p><b>Contract Package No: W-02</b></p> <p><b>Name of Polder : 40/2</b></p>	<p><b>Name of Activity: Re-excavation of Khal</b></p> <p><b>Location:</b></p> <p><b>Date of Inspection:</b></p> <p><b>Inspected by:</b></p>
--	---

SI No.	Activities/ Aspects	Actions to be taken / Inspection items	Monitoring Frequency (1,D,W,M,Y*)	Means of monitoring	Compliant(Y/N) Repeating on- compliance(R)			Remarks
01.	Re-excavation works	<ul style="list-style-type: none"> <li>• Spoil plan (volume to be dredged; disposal site to be used; quality of dredged material; applicability of the dredged material) to be developed for approval by Engineer</li> <li>• Unnecessary re-suspension will be avoided by selection of suitable dredging equipment.</li> <li>• Temporarily deposition of dredged material will be away from the channel edge to limit damage to streamside and stream habitats.</li> <li>• Return water will be conveyed through siltation chambers to avoid high loads of fines to be discharged on surface water.</li> <li>• Where applicable biotechnical engineering, for example geo textiles, may be used to help stabilize the material.</li> <li>• Smothering of important flora and habitats will be avoided</li> <li>• Provide solid demarcation around the excavation</li> <li>• Establish sufficient sign /signalling that can be visible at night</li> <li>• Erect light reflective signboard</li> <li>• Set and check the stability of excavator after</li> </ul>	<p>1</p> <p>W</p> <p>W</p> <p>W</p> <p>1</p> <p>W</p>	<p>Document Lab report</p> <p>Field visit</p>				

SI No.	Activities/ Aspects	Actions to be taken / Inspection items	Monitoring Frequency (1,D,W,M,Y*)	Means of monitoring	Compliant(Y/N) Repeating on- compliance(R)			Remarks
		certain interval during work • Conduct the toolbox talk before starting the work						
02.	Training	<ul style="list-style-type: none"> <li>• Environmental training on EMP will be arranged for Construction Supervisors, Foreman, Plant operators, Drivers.</li> <li>• Monitor number of new workers receiving OHS training</li> <li>• Monitor number workers receiving training, dates of training</li> </ul>	M	Document				
03.	Occupational Health and Safety	<ul style="list-style-type: none"> <li>• Development of Health and Safety Plan including emergency procedures</li> <li>• Train all staff in health and safety</li> <li>• Provision of HIV, including STI (sexually transmitted infections) information, education and communication.</li> <li>• Provision of PPE and ensuring their use (% of workers using full PPE, partial)</li> <li>• Provision and use of life jacket during visiting campsite/work site by boat (number of life jacket available, number of people on board of boat)</li> <li>• Installation of first aid facilities at work site and camps with adequate stock</li> <li>• Provide sanitation facilities where needed (Number of users/facility, conditions)</li> <li>• Provision of safe drinking water to work force (tube-well water, bottled water or pond water)</li> <li>• Proper signalling of work areas</li> <li>• Health screening of each worker (and every new worker) with proper documentation</li> <li>• Tool box talk is conducted everyday</li> <li>• Site plan is reviewed by the environmental manager of contractor before commencement of</li> </ul>	1 6M 1 M M 1 1 W M M D Y	Document Document Field visit Ditto				

SI No.	Activities/ Aspects	Actions to be taken / Inspection items	Monitoring Frequency (1,D,W,M,Y*)	Means of monitoring	Compliant(Y/N) Repeating on- compliance(R)			Remarks
		the work.						
04.	Public Health and Safety	<ul style="list-style-type: none"> <li>Notification of the public adjacent to the construction areas</li> <li>Installation of dedicated pathways for pedestrians</li> <li>Proper signalling of work areas</li> <li>Limitation of construction vehicles at public roads during peak hours.</li> <li>The temporary traffic detours in settlement areas will be kept free of dust by frequent application of water.</li> <li>Construction activities will be undertaken according to during daylight working hours between the hours of 07:00 – 17:00 on weekdays.</li> <li>Minimize dust by wetting pedestrian pathways</li> <li>Inform GRM</li> </ul>	<p>M</p> <p>Y</p> <p>M</p> <p>M</p> <p>W</p> <p>W</p> <p>D</p> <p>M</p>	Field visit				
05.	Solid Waste Management	<ul style="list-style-type: none"> <li>Ensuring collection and disposal of solid wastes within the construction camps and work areas</li> <li>Establish measures for Waste collection, transportation and disposal systems at approved disposal sites. (register disposal time and means)</li> <li>Disposal of construction and demolition waste. (quantity, location, by whom)</li> </ul>	<p>M</p> <p>1</p> <p>M</p>	<p>Field visit</p> <p>Document</p>				
06.	Air	<ul style="list-style-type: none"> <li>Regular maintenance of vehicles</li> <li>Covering or wetting of dusty materials</li> <li>Dust suppression by wetting surfaces</li> <li>Impose speed limits</li> <li>Re-vegetate bare surfaces soonest</li> </ul>	<p>M</p> <p>M</p> <p>W</p> <p>W</p> <p>M</p>	Field visit				
07.	Monitoring of Air Quality	<ul style="list-style-type: none"> <li>Performance of air quality tests at selected sensitive sites for parameters SPM2.5/10 during working hours.</li> </ul>	Y	<p>Lab report analyses</p> <p>Field Visit</p>				

SI No.	Activities/ Aspects	Actions to be taken / Inspection items	Monitoring Frequency (1,D,W,M,Y*)	Means of monitoring	Compliant(Y/N) Repeating on- compliance(R)			Remarks
		<ul style="list-style-type: none"> <li>• Number of working blowers</li> <li>• Number of watering per day</li> <li>• Number of complains on air quality</li> <li>• Warnings given by environmentalist</li> <li>• Actions taken to resolve</li> <li>• Highlights of quarry dust control (covers, sprays, operational status)</li> <li>• % of spoil lorries with covers</li> <li>• Action taken for uncovered vehicles</li> </ul>	M M W M M M M	Document  Field Visit  Document				
08.	Noise	<ul style="list-style-type: none"> <li>• Notify nearby population prior to any typical noise events</li> <li>• Ensure construction activities do not generate unacceptably high level of noise</li> <li>• Restrict working to daylight hours</li> <li>• Locate noisy equipment/ facilities away from sensitive receptors</li> </ul>	1  M W W	Field visit				
09.	Monitoring of Noise Quality	<ul style="list-style-type: none"> <li>• Condition of noise from vehicles/equipment (subjective judgment by environmentalist)</li> <li>• Warnings given by environmentalist</li> <li>• Number of noise related complains</li> <li>• Actions taken to resolve.</li> </ul>	M  M W W	Field visit  Document				
10.	Water and Hydrology	<ul style="list-style-type: none"> <li>• Preventing waste, soil, etc. entering in the water system by waste collection, re-vegetation and dust suppression etc.</li> <li>• Insure proper drainage of working areas e.g. perimeters lines must be provided with open shallow drains</li> </ul>	M  M	Field visit				
11.	Flora (tree) and Fauna	<ul style="list-style-type: none"> <li>• Agreeing with local authorities on tree felling.</li> <li>• Document trees/area of trees.</li> <li>• Avoid/prevent un-necessary tree vegetation cutting and clearing.</li> <li>• Re-vegetate disturbed construction and ancillary</li> </ul>	1 1 M 1	Document and Field visit				

SI No.	Activities/ Aspects	Actions to be taken / Inspection items	Monitoring Frequency (1,D,W,M,Y*)	Means of monitoring	Compliant(Y/N) Repeating on- compliance(R)			Remarks
		site surfaces. • Prevent disturbance of animals • Ensuring sufficient free flow of water in the construction work areas for fish migration	M					
12.	Monitoring of Surface Water Quality	• Performance of analyses on surface water (river, khal, beel and pond) for: pH, TDS, DO, BOD, EC/ Salinity and Turbidity.	Y	Lab report				
13.	Deployment Chinese EHS Manager and Local EHS Officer	• Employ one full-time • Number of days worked • Number of full inspections & partial inspections • Reports to project management	1  M	Document ditto				
14.	Complaints on health safety, Environmental hazards and GRM	• Grievance Redress Mechanism will be established. • Complaints received from the public or other stake holders will be registered and recorded and be brought to the attention of the Site Engineer. • All environmental incidents occurring on the site will be recorded and be brought to the attention of the Site Engineer. • Action will be taken within 7 working days.	1  W  W  M	Document				
15.	Reporting and Documentation	• The following records will be kept at site: • Environmental Monitoring Results <ul style="list-style-type: none"> <li>○ Contractors self-assessment record/results</li> <li>○ Register of non-compliance</li> <li>○ Register of corrective actions</li> <li>○ Monthly Environmental Reports</li> </ul>	M	Document				
16	Public Disclosure and Consultation	• Discussion meetings amongst stakeholders shall be organized by the contractor before commencement of major physical works of the project • Conduct public consultation as necessary during project implementation						



SI No.	Activities/ Aspects	Actions to be taken / Inspection items	Monitoring Frequency (1,D,W,M,Y*)	Means of monitoring	Compliant(Y/N) Repeating on- compliance(R)			Remarks
		<ul style="list-style-type: none"> <li>• Disclose the relevant project documents to local community</li> <li>• Establish rapport with community to liaise with community</li> <li>• Avoid religious conflict</li> <li>•</li> </ul>						
17	Labour influx	<ul style="list-style-type: none"> <li>• Appoint local labor</li> <li>• Provide required facilities</li> <li>• Assure required wage</li> <li>• Provide leave according their demand</li> <li>• Provide required PPE</li> <li>• Follow labour rule</li> <li>• Assure rest room</li> <li>• Provide FAF</li> <li>• Allow to pray</li> <li>• Always respect their norms and values</li> </ul>						
18	Traffic management/communication	<ul style="list-style-type: none"> <li>• Secure Safety and amenity of road users and the public;</li> <li>• Provide proper access to local communities;</li> <li>• Project identification, including project information and site signage;</li> <li>• Traffic and road user delay and inconvenience management;</li> <li>• Erect speed limit signage;</li> <li>• Traffic transfer (switch) arrangements;</li> <li>• Establish Traffic and Safety Management Responsibilities;</li> <li>• Provide separation between the public and the works.</li> <li>• Provide safety to both construction crews and the public;</li> <li>• Minimizing disruption during peak traffic periods;</li> </ul>	W	Visual observation				

SI No.	Activities/ Aspects	Actions to be taken / Inspection items	Monitoring Frequency (1,D,W,M,Y*)	Means of monitoring	Compliant(Y/N) Repeating on- compliance(R)			Remarks
		<ul style="list-style-type: none"> <li>• Providing traffic control to avoid traffic conflicts and minimize delays;</li> <li>• Reduce potential distraction of road users;</li> <li>• Community consultation and notification;</li> <li>• Avoiding the hazardous movements;</li> <li>• The minimum width specified by the road authority,</li> <li>• Kept well maintained while in operation;</li> <li>• Regular maintaining the vehicle,</li> <li>• Avoid vehicle movement during peak period.</li> </ul>						
19	Tool-box talk	<ul style="list-style-type: none"> <li>• Careful to work</li> <li>• Use of required PPE</li> <li>• Follow safety procedures</li> <li>• Follow speed limit</li> <li>• Special attention to community</li> <li>• Special attention to aquatic animal</li> <li>• Special attention to rare species</li> <li>• Maintaining water quality</li> <li>• Reserve the community path</li> <li>• Assure fish and aquatic movement</li> </ul>	W	Visit				

## Annex-8: Monitoring Checklist for Construction of Flood Wall

<p><b>Name of the Project: Coastal Embankment Improvement Project, Phase-1</b></p> <p><b>Contract Package No: W-02</b></p> <p><b>Name of Polder : 40/2</b></p>	<p><b>Name of Activity: Construction of Flood Wall</b></p> <p><b>Location:</b></p> <p><b>Date of Inspection:</b></p> <p><b>Inspected by:</b></p>
--	--

Sl No.	Activities/ Aspects	Actions to be taken / Inspection items	Monitoring Frequency (1,D,W,M,Y*)	Means of monitoring	Compliant(Y/N) Repeating on- compliance(R)			Remarks
01.	RCC Flood wall construction	<ul style="list-style-type: none"> <li>• Workers will be equipped with proper PPE.</li> <li>• Piling rig area to be marked and temporarily fenced.</li> <li>• MS Bar cutting and bending activities to be done in a designated separate place</li> <li>• Concreting and piling work will not take place at night.</li> <li>• Stacks with sand/cement will be covered properly by HDPE or tin Shed.</li> </ul>	<p>D</p> <p>D</p> <p>W</p> <p>W</p> <p>M</p>	Field visit				
02.	Manufacture of pre-cast CC blocks	<ul style="list-style-type: none"> <li>• Provide noise control barrier around the plant area as possible</li> <li>• Make a closed chamber for plant operator</li> <li>• Periodic hearing check for the exposed workers</li> <li>• Shifting duty for the noise exposed areas</li> <li>• Spray water at certain intervals in the plant area</li> <li>• Wet and clean the aggregate before using</li> <li>• Cover/wet dusty parts or materials</li> <li>• No operation without the screen or barrier provided with the machine</li> <li>• Conduct toolbox talk regularly</li> </ul>	<p>1</p> <p>1</p> <p>Y</p> <p>D</p> <p>D</p> <p>1</p> <p>1</p> <p>1</p> <p>1</p> <p>D</p>	Field visit				

SI No.	Activities/ Aspects	Actions to be taken / Inspection items	Monitoring Frequency (1,D,W,M,Y*)	Means of monitoring	Compliant(Y/N) Repeating on- compliance(R)			Remarks
		<ul style="list-style-type: none"> <li>• Establish and practice the safe operation procedure</li> <li>• Regular checking of Automatic CC plant</li> <li>• Check electric switch, fuel and all types connection line during off and on the plant.</li> <li>• Reserve the key with the designated person only</li> <li>• Conduct proper repair, whenever required</li> <li>• Properly cover the conveyer system</li> <li>• Check the roller system before and after the work every day or at regular intervals</li> <li>• Regular check on the belt systems</li> <li>• Regular check on conveyer systems</li> <li>• Make protective fence or moveable barrier around the hopper hole</li> <li>• Regular check on weir system</li> <li>• Proper maintenance of hopper</li> <li>• Change the weir immediate when need</li> <li>• Check the lock before use</li> <li>• Regular check and maintenance of hopper before loading</li> <li>• Use ear plug and ear muff before starting the work</li> <li>• Set the equipment at one open site away from the plant area, curing area, living area</li> <li>• Use ear plug and ear muff before starting the concrete core cutting</li> <li>• Set the core cutting equipment at one open site away from the plant area, curing area, living area</li> <li>• Provide continuous water flow during cutting operation by pipe</li> <li>• Spray water at during intervals at stockpile areas</li> </ul>	<p style="text-align: center;">1</p> <p style="text-align: center;">M</p> <p style="text-align: center;">W</p> <p style="text-align: center;">D</p> <p style="text-align: center;">Y</p> <p style="text-align: center;">1</p> <p style="text-align: center;">D</p> <p style="text-align: center;">W</p> <p style="text-align: center;">W</p> <p style="text-align: center;">M</p> <p style="text-align: center;">W</p> <p style="text-align: center;">W</p> <p style="text-align: center;">W</p> <p style="text-align: center;">D</p> <p style="text-align: center;">W</p> <p style="text-align: center;">D</p> <p style="text-align: center;">1</p> <p style="text-align: center;">D</p> <p style="text-align: center;">1</p> <p style="text-align: center;">D</p> <p style="text-align: center;">D</p>					

SI No.	Activities/ Aspects	Actions to be taken / Inspection items	Monitoring Frequency (1,D,W,M,Y*)	Means of monitoring	Compliant(Y/N) Repeating on- compliance(R)			Remarks
		<ul style="list-style-type: none"> <li>• Make a wall around the storage area. The height will be related to the height of stockpiling</li> <li>• Make stockpile area as no entry zone</li> <li>• Provide cautionary signboard at stockpile areas</li> <li>• Demarcate the CC block stacking area</li> <li>• Provide cautionary signboard at CC block stacking areas</li> <li>• Make CC block stacking area as no entry zone</li> <li>• Regular check the switch board and weir system</li> <li>• Turn off the main switch board</li> <li>• Use the fire-extinguisher and sand as required</li> <li>• Rise the wire system up or underground conduit system should be established</li> <li>• All joint will be insulated</li> <li>• Closed all the switch board properly. Only responsible person will check at regular intervals</li> <li>• Provide the gas mask properly during welding</li> <li>• Provide special cloth for welding</li> <li>• Provide the eye protective welding glass</li> <li>• Maintain a minimum distance (6.1 m) from the fuel gas cylinder</li> <li>• Check the hose pipe system regularly</li> <li>• Workers will be equipped with proper PPE.</li> <li>• Signals will be installed to indicate the entry and exits and movement of vehicles in the work area.</li> <li>• Care during use of forklifts to transfer CC Blocks</li> <li>• Manufacturing only can take place at night within proper environmental protective measurement.</li> <li>• Stacks with sand will be covered or wetted.</li> <li>• Use hand gloves during operation</li> </ul>	<p>1</p> <p>1</p> <p>Y</p> <p>M</p> <p>M</p> <p>Y</p> <p>W</p> <p>W</p> <p>M</p> <p>1</p> <p>1</p> <p>1</p> <p>Y</p> <p>Y</p> <p>1</p> <p>M</p> <p>D</p> <p>M</p> <p>M</p> <p>D</p> <p>D</p> <p>D</p>					

SI No.	Activities/ Aspects	Actions to be taken / Inspection items	Monitoring Frequency (1,D,W,M,Y*)	Means of monitoring	Compliant(Y/N) Repeating on- compliance(R)			Remarks
		<ul style="list-style-type: none"> <li>• Check the plate joint regularly, about its stability</li> <li>• Worker's standing area should maintain certain distance from the loading and unloading area</li> <li>• Checking silo surface for avoidance leakage</li> <li>• Avoid excess load in silo</li> <li>• Signal man</li> <li>• Assure Required Signage</li> </ul>	D 1 1 1 D M					
03.	The bank and slope protection works	<ul style="list-style-type: none"> <li>• Spilling of earth material in surface water will be avoided.</li> <li>• Turfing will be applied to prevent erosion.</li> <li>• Proper drainage provision will be kept to avoid formation of rain cuts due to surface runoff.</li> </ul>	W W M	Field visit				
04.	Training	<ul style="list-style-type: none"> <li>• Environmental training on EMP will be arranged for Construction Supervisors, Foreman, Plant operators, Drivers.</li> <li>• Monitor number of new workers receiving OHS training</li> <li>• Monitor number workers receiving training, dates of training</li> </ul>	M	Document				
05.	Occupational Health and Safety	<ul style="list-style-type: none"> <li>• Development of Health and Safety Plan including emergency procedures</li> <li>• Train all staff in health and safety</li> <li>• Provision of HIV, including STI (sexually transmitted infections) information, education and communication.</li> <li>• Provision of PPE and ensuring their use (% of workers using full PPE, partial)</li> <li>• Provision and use of life jacket during visiting campsite/work site by boat (number of life jacket available, number of people on board of boat)</li> <li>• Installation of first aid facilities at work site and camps with adequate stock</li> </ul>	1 6M 1 M M 1	Document Document Field visit Ditto				

SI No.	Activities/ Aspects	Actions to be taken / Inspection items	Monitoring Frequency (1,D,W,M,Y*)	Means of monitoring	Compliant(Y/N) Repeating on- compliance(R)			Remarks
		<ul style="list-style-type: none"> <li>• Provide sanitation facilities where needed (Number of users/facility, conditions)</li> <li>• Provision of safe drinking water to work force (tube-well water, bottled water or pond water)</li> <li>• Proper signalling of work areas</li> <li>• Health screening of each worker (and every new worker) with proper documentation</li> <li>• Tool box talk is conducted everyday</li> <li>• Site plan is reviewed by the environmental manager of contractor before commencement of the work.</li> </ul>	1 W M M D Y					
06.	Public Health and Safety	<ul style="list-style-type: none"> <li>• Notification of the public adjacent to the construction areas</li> <li>• Installation of dedicated pathways for pedestrians</li> <li>• Proper signalling of work areas</li> <li>• Limitation of construction vehicles at public roads during peak hours.</li> <li>• The temporary traffic detours in settlement areas will be kept free of dust by frequent application of water.</li> <li>• Construction activities will be undertaken according to during daylight working hours between the hours of 07:00 – 17:00 on weekdays.</li> <li>• Minimize dust by wetting pedestrian pathways</li> <li>• Inform GRM</li> </ul>	M Y M M W W D M	Field visit				
07.	Solid Waste Management	<ul style="list-style-type: none"> <li>• Ensuring collection and disposal of solid wastes within the construction camps and work areas</li> <li>• Establish measures for Waste collection, transportation and disposal systems at approved disposal sites. (register disposal time and means)</li> </ul>	M 1	Field visit  Document				

SI No.	Activities/ Aspects	Actions to be taken / Inspection items	Monitoring Frequency (1,D,W,M,Y*)	Means of monitoring	Compliant(Y/N) Repeating on- compliance(R)			Remarks
		<ul style="list-style-type: none"> <li>Disposal of construction and demolition waste. (quantity, location, by whom)</li> </ul>	M					
08.	Air	<ul style="list-style-type: none"> <li>Regular maintenance of vehicles</li> <li>Covering or wetting of dusty materials</li> <li>Dust suppression by wetting surfaces</li> <li>Impose speed limits</li> <li>Re-vegetate bare surfaces soonest</li> </ul>	M M W W M	Field visit				
09.	Monitoring of Air Quality	<ul style="list-style-type: none"> <li>Performance of air quality tests at selected sensitive sites for parameters SPM2.5/10 during working hours.</li> <li>Number of working blowers</li> <li>Number of watering per day</li> <li>Number of complains on air quality</li> <li>Warnings given by environmentalist</li> <li>Actions taken to resolve</li> <li>Highlights of quarry dust control (covers, sprays, operational status)</li> <li>% of spoil lorries with covers</li> <li>Action taken for uncovered vehicles</li> </ul>	Y  M M W M M M M	Lab report analyses  Field Visit  Document  Field Visit  Document				
10.	Noise	<ul style="list-style-type: none"> <li>Notify nearby population prior to any typical noise events</li> <li>Ensure construction activities do not generate unacceptably high level of noise</li> <li>Restrict working to daylight hours</li> <li>Locate noisy equipment/ facilities away from sensitive receptors</li> </ul>	1  M W W	Field visit				
11.	Monitoring of Noise Quality	<ul style="list-style-type: none"> <li>Condition of noise from vehicles/equipment (subjective judgment by environmentalist)</li> <li>Warnings given by environmentalist</li> <li>Number of noise related complains</li> <li>Actions taken to resolve.</li> </ul>	M  M W W	Field visit  Document				



SI No.	Activities/ Aspects	Actions to be taken / Inspection items	Monitoring Frequency (1,D,W,M,Y*)	Means of monitoring	Compliant(Y/N) Repeating on- compliance(R)			Remarks
12.	Water and Hydrology	<ul style="list-style-type: none"> <li>Preventing waste, soil, etc. entering in the water system by waste collection, re-vegetation and dust suppression etc.</li> <li>Insure proper drainage of working areas e.g. perimeters lines must be provided with open shallow drains</li> </ul>	M  M	Field visit				
13.	Monitoring of surface water quality	<ul style="list-style-type: none"> <li>Test surface water quality as per EMP (TDS, Turbidity, pH, DO, BOD, COD)</li> </ul>	Y	Lab report				
14.	Flora (tree) and Fauna	<ul style="list-style-type: none"> <li>Agreeing with local authorities on tree felling.</li> <li>Document trees/area of trees.</li> <li>Avoid/prevent un-necessary tree vegetation cutting and clearing.</li> <li>Re-vegetate disturbed construction and ancillary site surfaces.</li> <li>Prevent disturbance of animals</li> <li>Ensuring sufficient free flow of water in the construction work areas for fish migration</li> </ul>	1 1 M  1  M	Document Document Field Visit Ditto				
15.	Deployment Chinese EHS Manager and Local EHS Officer	<ul style="list-style-type: none"> <li>Employ one full-time</li> <li>Number of days worked</li> <li>Number of full inspections &amp; partial inspections</li> <li>Reports to project management</li> </ul>	1  M	Document ditto				
16.	Complaints on health safety, Environmental hazards and GRM	<ul style="list-style-type: none"> <li>Grievance Redress Mechanism will be established.</li> <li>Complaints received from the public or other stake holders will be registered and recorded and be brought to the attention of the Site Engineer.</li> <li>All environmental incidents occurring on the site will be recorded and be brought to the attention of the Site Engineer.</li> <li>Action will be taken within 7 working days.</li> </ul>	1  W W  M	Document				
17.	Reporting and Documentation	<ul style="list-style-type: none"> <li>The following records will be kept at site:</li> <li>Environmental Monitoring Results</li> </ul>	M	Document				

SI No.	Activities/ Aspects	Actions to be taken / Inspection items	Monitoring Frequency (1,D,W,M,Y*)	Means of monitoring	Compliant(Y/N) Repeating on- compliance(R)			Remarks
		<ul style="list-style-type: none"> <li>○ Contractors self-assessment record/results</li> <li>○ Register of non-compliance</li> <li>○ Register of corrective actions</li> <li>○ Monthly Environmental Reports</li> </ul>						
18	Public Disclosure and Consultation	<ul style="list-style-type: none"> <li>● Discussion meetings amongst stakeholders shall be organized by the contractor before commencement of major physical works of the project</li> <li>● Conduct public consultation as necessary during project implementation</li> <li>● Disclose the relevant project documents to local community</li> <li>● Establish rapport with community to liaise with community</li> <li>● Avoid religious conflict</li> </ul>						
19	Labour influx	<ul style="list-style-type: none"> <li>● Appoint local labor</li> <li>● Provide required facilities</li> <li>● Assure required wage</li> <li>● Provide leave according their demand</li> <li>● Provide required PPE</li> <li>● Follow labour rule</li> <li>● Assure rest room</li> <li>● Provide FAF</li> <li>● Allow to pray</li> <li>● Always respect their norms and values</li> </ul>						
20	Traffic management/communication	<ul style="list-style-type: none"> <li>● Secure Safety and amenity of road users and the public;</li> <li>● Provide proper access to local communities;</li> <li>● Project identification, including project information and site signage;</li> <li>● Traffic and road user delay and inconvenience management;</li> </ul>	W	Visual observation				

SI No.	Activities/ Aspects	Actions to be taken / Inspection items	Monitoring Frequency (1,D,W,M,Y*)	Means of monitoring	Compliant(Y/N) Repeating on- compliance(R)			Remarks
		<ul style="list-style-type: none"> <li>• Erect speed limit signage;</li> <li>• Traffic transfer (switch) arrangements;</li> <li>• Establish Traffic and Safety Management Responsibilities;</li> <li>• Provide separation between the public and the works.</li> <li>• Provide safety to both construction crews and the public;</li> <li>• Minimizing disruption during peak traffic periods;</li> <li>• Providing traffic control to avoid traffic conflicts and minimize delays;</li> <li>• Reduce potential distraction of road users;</li> <li>• Community consultation and notification;</li> <li>• Avoiding the hazardous movements;</li> <li>• The minimum width specified by the road authority,</li> <li>• Kept well maintained while in operation;</li> <li>• Regular maintaining the vehicle,</li> <li>• Avoid vehicle movement during peak period.</li> </ul>						
21	Tool-box talk	<ul style="list-style-type: none"> <li>• Careful to work</li> <li>• Use of required PPE</li> <li>• Follow safety procedures</li> </ul>	1	Visit				

## Annex-9: Monitoring Checklist for Afforestation

<p><b>Name of the Project: Coastal Embankment Improvement Project, Phase-1</b></p> <p><b>Contract Package No: W-02</b></p> <p><b>Name of Polder : 40/2</b></p>	<p><b>Name of Activity: Afforestation</b></p> <p><b>Location:</b></p> <p><b>Date of Inspection:</b></p> <p><b>Inspected by:</b></p>
--	---

SI No.	Activities/ Aspects	Actions to be taken / Inspection items	Monitoring Frequency (1,D,W,M,Y*)	Mean of monitoring	Compliant(Y/N) Repeatingnon-compliance(R)			Remarks
01.	Water and Hydrology	<ul style="list-style-type: none"> <li>• Preventing waste, soil, etc. entering in the water system by waste collection, re-vegetation and dust suppression etc.</li> <li>• Insure proper drainage of working areas e.g. perimeters lines must be provided with open shallow drains</li> </ul>	M  M	Field visit				
02.	Flora and Fauna	<ul style="list-style-type: none"> <li>• Document trees/area of trees.</li> <li>• Avoid/prevent un-necessary tree vegetation cutting and clearing.</li> <li>• Re-vegetate disturbed construction and ancillary site surfaces.</li> <li>• Prevent disturbance of animals</li> <li>• Ensuring sufficient free flow of water in the construction work areas for fish migration</li> </ul>	1 1 M 1  M	Document Field Visit Ditto				
03.	Deployment Chinese EHS Manager and Local EHS Officer	<ul style="list-style-type: none"> <li>• Employ one full-time</li> <li>• Number of days worked</li> <li>• Number of full inspections &amp; partial inspections</li> <li>• Reports to project management</li> </ul>	1  M	Document ditto				

SI No.	Activities/ Aspects	Actions to be taken / Inspection items	Monitoring Frequency (1,D,W,M,Y*)	Mean sof monitoring	Compliant(Y/N) Repeatingnon-compliance(R)			Remarks
04.	Complaints on health safety, Environmental hazards and GRM	<ul style="list-style-type: none"> <li>Grievance Redress Mechanism will be established.</li> <li>Complaints received from the public or other stake holders will be registered and recorded and be brought to the attention of the Site Engineer.</li> <li>All environmental incidents occurring on the site will be recorded and be brought to the attention of the Site Engineer.</li> <li>Action will be taken within 7 working days.</li> </ul>	1 W W M	Document				
05.	Reporting and Documentation	<ul style="list-style-type: none"> <li>The following records will be kept at site:</li> <li>Environmental Monitoring Results                             <ul style="list-style-type: none"> <li>Contractors self-assessment record/results</li> <li>Register of non-compliance</li> <li>Register of corrective actions</li> <li>Monthly Environmental Reports</li> </ul> </li> </ul>	M	Document				
06	Public Disclosure and Consultation	<ul style="list-style-type: none"> <li>Discussion meetings amongst stakeholders shall be organized by the contractor before commencement of major physical works of the project</li> <li>Conduct public consultation as necessary during project implementation</li> <li>Disclose the relevant project documents to local community</li> <li>Establish rapport with community to liaise with community</li> <li>Avoid religious conflict</li> </ul>						
07	Labour influx	<ul style="list-style-type: none"> <li>Appoint local labor</li> <li>Provide required facilities</li> <li>Assure required wedge</li> <li>Provide leave according their demand</li> <li>Provide required PPE</li> <li>Follow labour rule</li> </ul>						

SI No.	Activities/ Aspects	Actions to be taken / Inspection items	Monitoring Frequency (1,D,W,M,Y*)	Mean sof monitoring	Compliant(Y/N) Repeatingnon-compliance(R)			Remarks
		<ul style="list-style-type: none"> <li>Assure rest room</li> <li>Provide FAF</li> <li>Allow to pray</li> <li>Always respect their norms and values</li> </ul>						
08	Traffic management	<ul style="list-style-type: none"> <li>Safety and amenity of road users and the public;</li> <li>Site security, site access and signage;</li> <li>Project identification, including project information and site signage;</li> <li>Traffic and road user delay and inconvenience management;</li> <li>Speed limit signage;</li> <li>Traffic transfer (switch) arrangements and procedures;</li> <li>Traffic and Safety Management Responsibilities;</li> <li>Providing separation between the public and the works.</li> <li>Provide safety to both construction crews and the public;</li> <li>Minimizing disruption during peak traffic periods;</li> <li>Providing traffic control to avoid traffic conflicts and minimize delays;</li> <li>Reduce potential distraction of road users;</li> <li>Community consultation and notification;</li> <li>Avoiding the hazardous movements;</li> <li>The minimum width specified by the road authority,</li> <li>Kept well maintained while in operation;</li> <li>Regular maintaining the vehicle,</li> <li>Avoid vehicle movement during peak period.</li> </ul>	W	Visual observation				
09	Tool-box talk	<ul style="list-style-type: none"> <li>Careful to earth work</li> <li>Use of required PPE</li> <li>Obey to public right</li> </ul>	1	Visit				

### Annex-10: Monitoring Checklist for Demobilization work

<p><b>Name of the Project: Coastal Embankment Improvement Project, Phase-1</b></p> <p><b>Contract Package No: W-02</b></p> <p><b>Name of Polder: 40/2</b></p>	<p><b>Name of Activity: Demobilization work</b></p> <p><b>Location:</b></p> <p><b>Date of Inspection:</b></p> <p><b>Inspected by:</b></p>
---	---

SI No.	Activities/ Aspects	Actions to be taken / Inspection items	Monitoring Frequency (1,D,W,M,Y*)	Means of monitoring	Compliant(Y/N) Repeating on- compliance (R)			Remarks
01.	Temporary Facilities Decommissioning	<ul style="list-style-type: none"> <li>• Agreeing with local authorities on demolition</li> <li>• Review of environmental liabilities</li> <li>• Waste removal</li> <li>• General re-instatement of site</li> <li>• Re-vegetation implementation</li> <li>• Close-out check</li> </ul>	1  1 1 1 1 1	Document  Field visit				
02.	Occupational Health and Safety	<ul style="list-style-type: none"> <li>• Development of Health and Safety Plan including emergency procedures</li> <li>• Train all staff in health and safety</li> <li>• Provision of HIV, including STI (sexually transmitted infections) information, education and communication.</li> <li>• Provision of PPE and ensuring their use (% of workers using full PPE, partial)</li> <li>• Provision and use of life jacket during visiting campsite/work site by boat (number of life jacket available, number of people on board of boat)</li> <li>• Installation of first aid facilities at work site and camps with adequate stock</li> </ul>	1  6M 1  M  M  1  1	Document  Document  Field visit  Ditto				

SI No.	Activities/ Aspects	Actions to be taken / Inspection items	Monitoring Frequency (1,D,W,M,Y*)	Means of monitoring	Compliant(Y/N) Repeating on- compliance (R)			Remarks
		<ul style="list-style-type: none"> <li>• Provide sanitation facilities where needed (Number of users/facility, conditions)</li> <li>• Provision of safe drinking water to work force (tube-well water, bottled water or pond water)</li> <li>• Proper signalling of work areas</li> <li>• Health screening of each worker (and every new worker) with proper documentation</li> <li>• Tool box talk is conducted everyday</li> <li>• Site plan is reviewed by the environmental manager of contractor before commencement of the work.</li> </ul>	<p>W</p> <p>M</p> <p>M</p> <p>D</p> <p>Y</p>					
03.	Public Health and Safety	<ul style="list-style-type: none"> <li>• Notification of the public adjacent to the construction areas</li> <li>• Installation of dedicated pathways for pedestrians</li> <li>• Proper signalling of work areas</li> <li>• Limitation of construction vehicles at public roads during peak hours.</li> <li>• The temporary traffic detours in settlement areas will be kept free of dust by frequent application of water.</li> <li>• Construction activities will be undertaken according to during daylight working hours between the hours of 07:00 – 17:00 on weekdays.</li> <li>• Minimize dust by wetting pedestrian pathways</li> <li>• Inform GRM</li> </ul>	<p>M</p> <p>Y</p> <p>M</p> <p>M</p> <p>W</p> <p>W</p> <p>D</p> <p>M</p>	Field visit				
04.	Solid Waste Management	<ul style="list-style-type: none"> <li>• Ensuring collection and disposal of solid wastes within the construction camps and work areas</li> <li>• Taking measure to collect and store inorganic wastes in a safe place within the household and organic wastes cleared on daily basis to waste collector. (quantity/ number and size of bins)</li> <li>• Establish measures for Waste collection, transportation and disposal systems at approved</li> </ul>	<p>M</p> <p>M</p> <p>1</p>	<p>Field visit</p> <p>Document</p>				



SI No.	Activities/ Aspects	Actions to be taken / Inspection items	Monitoring Frequency (1,D,W,M,Y*)	Means of monitoring	Compliant(Y/N) Repeating on- compliance (R)			Remarks
		disposal sites. (register disposal time and means) • Disposal of construction and demolition waste. (quantity, location, by whom)	M					
05.	Air	<ul style="list-style-type: none"> <li>Regular maintenance of vehicles</li> <li>Covering or wetting of dusty materials</li> <li>Dust suppression by wetting surfaces</li> <li>Impose speed limits</li> <li>Re-vegetate bare surfaces soonest</li> </ul>	M M W W M	Field visit				
06.	Monitoring of Air Quality	<ul style="list-style-type: none"> <li>Performance of air quality tests at selected sensitive sites for parameters SPM2.5/10 during working hours.</li> <li>Number of working blowers</li> <li>Number of watering per day</li> <li>Number of complains on air quality</li> <li>Warnings given by environmentalist</li> <li>Actions taken to resolve</li> <li>Highlights of quarry dust control (covers, sprays, operational status)</li> <li>% of spoil lorries with covers</li> <li>Action taken for uncovered vehicles</li> </ul>	Y  M M W M M M M M	Lab report analyses  Field Visit  Document  Field Visit  Document				
07.	Noise	<ul style="list-style-type: none"> <li>Notify nearby population prior to any typical noise events</li> <li>Ensure construction activities do not generate unacceptably high level of noise</li> <li>Restrict working to daylight hours</li> <li>Locate noisy equipment/ facilities away from sensitive receptors</li> </ul>	1  M W W	Field visit				
08.	Monitoring of Noise Quality	<ul style="list-style-type: none"> <li>Condition of noise from vehicles/equipment (subjective judgment by environmentalist)</li> <li>Warnings given by environmentalist</li> <li>Number of noise related complains</li> <li>Actions taken to resolve.</li> </ul>	M  M W W	Field visit  Document				

SI No.	Activities/ Aspects	Actions to be taken / Inspection items	Monitoring Frequency (1,D,W,M,Y*)	Means of monitoring	Compliant(Y/N) Repeating on- compliance (R)			Remarks
09.	Water and Hydrology	<ul style="list-style-type: none"> <li>Preventing waste, soil, etc. entering in the water system by waste collection, re-vegetation and dust suppression etc.</li> <li>Insure proper drainage of working areas e.g. perimeters lines must be provided with open shallow drains</li> </ul>	M  M	Field visit				
10.	Flora (tree) and Fauna	<ul style="list-style-type: none"> <li>Agreeing with local authorities on tree felling.</li> <li>Document trees/area of trees.</li> <li>Avoid/prevent un-necessary tree vegetation cutting and clearing.</li> <li>Re-vegetate disturbed construction and ancillary site surfaces.</li> <li>Prevent disturbance of animals</li> <li>Ensuring sufficient free flow of water in the construction work areas for fish migration</li> </ul>	1 1 M  1  M	Document Document Field Visit Ditto				
11.	Deployment Chinese EHS Manager and Local EHS Officer	<ul style="list-style-type: none"> <li>Employ one full-time</li> <li>Number of days worked</li> <li>Number of full inspections &amp; partial inspections</li> <li>Reports to project management</li> </ul>	1  M	Document ditto				
12.	Complaints on health safety, Environmental hazards and GRM	<ul style="list-style-type: none"> <li>Grievance Redress Mechanism will be established.</li> <li>Complaints received from the public or other stake holders will be registered and recorded and be brought to the attention of the Site Engineer.</li> <li>All environmental incidents occurring on the site will be recorded and be brought to the attention of the Site Engineer.</li> <li>Action will be taken within 7 working days.</li> </ul>	1  W  W  M	Document				
13.	Reporting and Documentation	<ul style="list-style-type: none"> <li>The following records will be kept at site:</li> <li>Environmental Monitoring Results                             <ul style="list-style-type: none"> <li>Contractors self-assessment record/results</li> <li>Register of non-compliance</li> <li>Register of corrective actions</li> </ul> </li> </ul>	M	Document				

SI No.	Activities/ Aspects	Actions to be taken / Inspection items	Monitoring Frequency (1,D,W,M,Y*)	Means of monitoring	Compliant(Y/N) Repeating on- compliance (R)			Remarks
		<ul style="list-style-type: none"> <li>○ Monthly Environmental Reports</li> </ul>						
14	Traffic management/communication	<ul style="list-style-type: none"> <li>• Secure safety and amenity of road users and the public;</li> <li>• Provide proper access to local communities;</li> <li>• Project identification, including project information and site signage;</li> <li>• Traffic and road user delay and inconvenience management;</li> <li>• Erect speed limit signage;</li> <li>• Traffic transfer (switch) arrangements and procedures;</li> <li>• Establish Traffic and Safety Management Responsibilities;</li> <li>• Provide separation between the public and the works.</li> <li>• Provide safety to both construction crews and the public;</li> <li>• Minimizing disruption during peak traffic periods;</li> <li>• Providing traffic control to avoid traffic conflicts and minimize delays;</li> <li>• Reduce potential distraction of road users;</li> <li>• Community consultation and notification;</li> <li>• Avoiding the hazardous movements;</li> <li>• The minimum width specified by the road authority,</li> <li>• Kept well maintained while in operation;</li> <li>• Regular maintaining the vehicle,</li> <li>• Avoid vehicle movement during peak period.</li> </ul>	W	Visual observation				
15	Public Disclosure and Consultation	<ul style="list-style-type: none"> <li>• Discussion meetings amongst stakeholders shall be organized by the contractor before commencement of major physical works of the project</li> <li>• Conduct public consultation as necessary during project implementation</li> </ul>						

SI No.	Activities/ Aspects	Actions to be taken / Inspection items	Monitoring Frequency (1,D,W,M,Y*)	Means of monitoring	Compliant(Y/N) Repeating on- compliance (R)			Remarks
		<ul style="list-style-type: none"> <li>• Disclose the relevant project documents to local community</li> <li>• Establish rapport with community to liaise with community</li> <li>• Avoid religious conflict</li> </ul>						
16	Labour influx	<ul style="list-style-type: none"> <li>• Appoint local labor</li> <li>• Provide required facilities</li> <li>• Assure required wage</li> <li>• Provide leave according their demand</li> <li>• Provide required PPE</li> <li>• Follow labour rule</li> <li>• Assure rest room</li> <li>• Provide FAF</li> <li>• Allow to pray</li> <li>• Always respect their norms and values</li> </ul>						
17	Tool-box talk	<ul style="list-style-type: none"> <li>• Frequent uses of required PPE</li> <li>• Carefully loading the debris</li> <li>• Safe way for workers</li> </ul>	M	Visit				

(\*1=Once; D=Daily; W=Weakly; M=Monthly; Y=Yearly)

Annex-11: Lay out plan for Construction Camp

Site Plan for the Base Camp

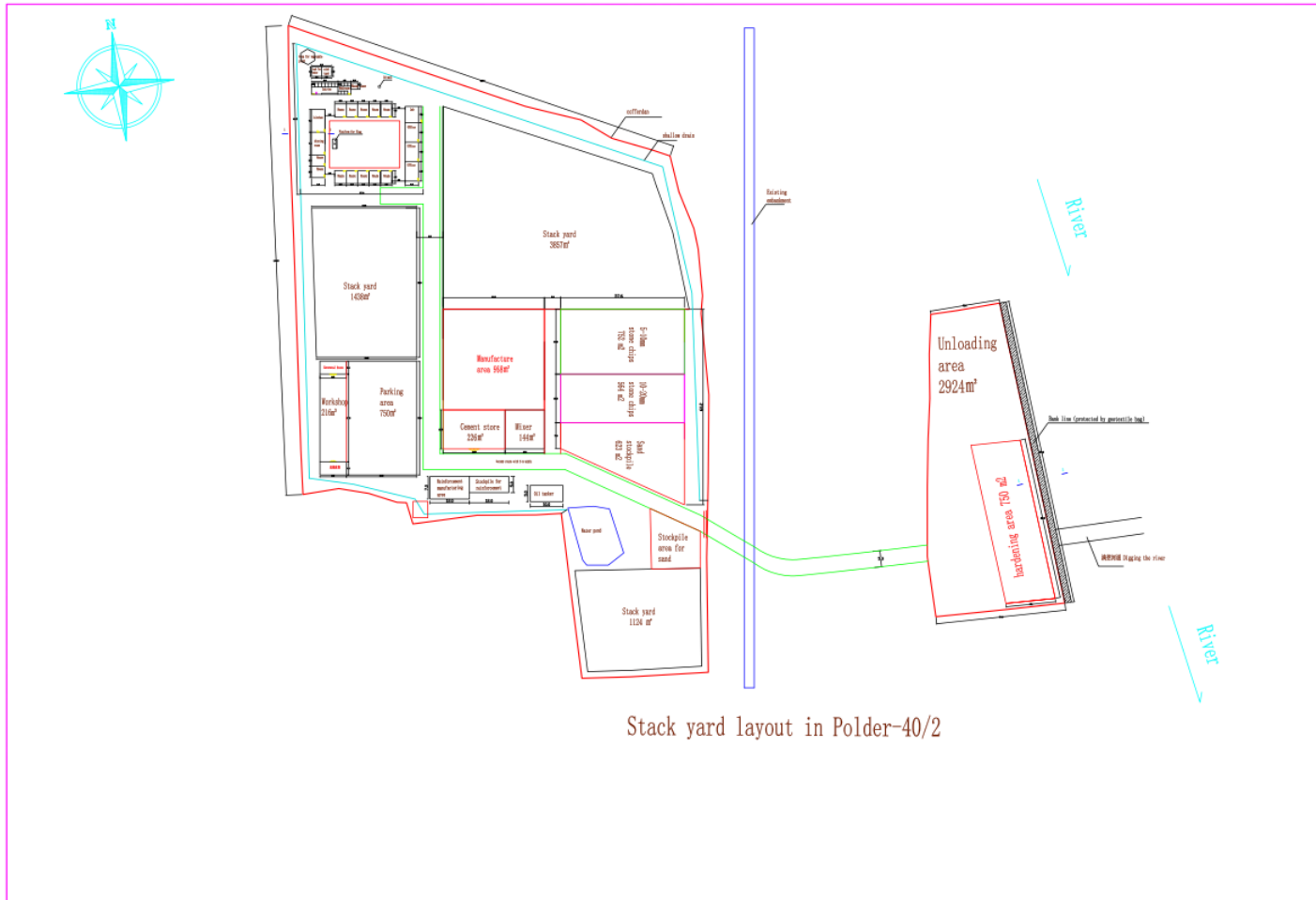

## Annex-12: GRM for Polder 40/2

As per EIA report (EIA Section 10.12) BWDB will establish a grievance redress mechanism (GRM) as a means to ensure social accountability and to answer queries and address complaints and grievances about any irregularities.

Several social and environmental issues may arise during implementation stages of the project. Potential sources of grievances from the affected people, concerned public, construction workers and civil society members may deal with:

- Soil, water, dust, noise and air pollution from construction related activities;
- Traffic movement and congestion;
- Lack of adequate safety at the construction areas and approach roads;
- Lack of water and sanitation facilities at the construction sites/camps;
- Waste disposal;
- Conflicts among construction workers and with local community;
- Disturbances to flora and fauna;
- Failure to comply with standards or contractual obligations.

A Public Relation Officer (PRO) will be nominated in each polder with assistance of local staff especially the local chairman. Before the construction activities in the surrounding area a GRM leaflet which is translated (both in Chinese and Bengali translated) will have to be distributed to the local people. The translated (both in Chinese and Bengali) GRM leaflet is attached herewith.

The contents of GRM leaflets will contain the following information:

- Nature of the work,
- Location of work, Duration of the Work,
- The possible risk during the execution,
- The contact person as well as the mobile phone number to whom complaint can be lodged.

PRO will keep a logbook to record all the complaints received including the following information:

- Name of complainer,
- Date and time of complaint,
- Mobile number of complainer,
- Issues complained,
- Action(s) taken.

The GRM logbook shall be checked, reviewed by the supervising engineer.

The GRM will also entertain concerns about matters of resettlement and land acquisition including livelihood restoration. The role here is to collect the complaints and forward the issues to the competent arrangements such as GRC (consisting of multi-stakeholders groups).

### **Membership of GRC**

1. Executive Engineer (BWDB Division Office): Convener
2. Representative of the RAP Implementing NGO: Member -Secretary
3. Local UP Member / Ward Councillor: Member
4. Teacher from Local Educational Institution(nominated by Upazilla Administration): Member
5. Representative from Local Women's Group: Member
6. Representative from the PAP Group: Member

# Coastal Embankment Improvement Project, Phase -1 (CEIP-1)

উপকূলবর্তী বাঁধ উন্নয়ন প্রকল্প, ফেজ-1(সিইআইপি-1), প্যাকেজ W-02

## অভিযোগ সমাধান প্রক্রিয়া (Grievance Redress Mechanism)

### পটভূমি (Background):

প্রকল্পটির মূল লক্ষ্যগুলি হল: প্রাকৃতিক দুর্যোগের সময় সম্পদ, ফসল এবং পশুদের ক্ষতি হ্রাস করা; • ঘূর্ণিঝড়ের মতো প্রাকৃতিক দুর্যোগের পরে পুনরুদ্ধারের সময় হ্রাস করা; • জলবায়ু পরিবর্তন ঘটাতে লবণাক্ত পানির অনুপ্রবেশকে হ্রাস করে কৃষি উৎপাদন উন্নত করা; এবং • উপযুক্ত সফট বা জরুরী অবস্থার জন্য দ্রুত এবং কার্যকরীভাবে সাড়া দেওয়ার জন্য বাংলাদেশের ক্ষমতার উন্নতি করা। • সিইআইপি -1 এর বিবেচনায় বিনিয়োগকারীদের মধ্যে বিদ্যমান বাঁধ সিস্টেমের প্রায় 10 বছরের রিটার্ন সময়ের সুরক্ষা রয়েছে। বাঁধের বর্তমান অবস্থা সম্ভবত সিডর ও আইলার পরে দেখা যায় যে অতিরিক্ত চাপের ফলে বিদ্যমান দুর্বল অবস্থানে বাঁধের বিপর্যয়মূলক বিপর্যয় ঘটতে পারে। • প্রকল্পের প্রায় 100,817 হেক্টর এলাকাটি ২০১০ সালে বিদ্যমান জলবায়ু পরিবর্তনের শর্তাদির 25 বছরের রিটার্ন সময়ের বিরুদ্ধে সুরক্ষিত হবে। অতিরিক্ত নিরাপত্তার কারণগুলি হ্রাস এবং সমুদ্রের উচ্চতর অনুমানের উচ্চ অনুমানের অনুমতি দিয়েও তৈরি করা হয়েছে। ওঠা। প্রকল্পের সমাপ্তি (২০২২ বলুন) হওয়ার পরে শীঘ্রই প্রকৃত সুরক্ষা 50 বছরের রিটার্ন সময়ের চেয়ে বেশি হবে। • 86,36২ হেক্টর নেট চাষযোগ্য এলাকার বাঁধ নির্মাণ, ডেনেজ রেগুলেটর, পোল্ডারস ফ্লোয়িং ক্লসিং এবং পোলারদের নিকাশী চ্যানেল নির্মাণের মাধ্যমে। • সিডর ও আইলার চিত্রে বসন্ত জোয়ার বন্যা এবং ঘূর্ণিঝড় ঝড়ের ফলে ফসলের ক্ষতি হ্রাসের মাধ্যমে ফসল ফলন বৃদ্ধি। • প্রস্তাবিত ফ্লাশিং ইটলেট নির্মাণের মাধ্যমে পৃষ্ঠতলের পানি ব্যবহার করে একটি বিস্তৃত সেচ নেটওয়ার্কের অধীনে স্থানীয় থেকে এইচওয়াইভি ধানের ফসল থেকে সুইচ করুন, এবং • মাছের সংস্কৃতি, বোরো ফসল এবং টি-আমান চাষের বিস্তারের জন্য প্রকল্প এলাকার বিদ্যমান নিষ্কাশন ব্যবস্থা উন্নত করুন।

প্রকল্প বাস্তবায়ন সময়কাল (Project Implementation period): ২০১৩-২০২০।

বাস্তবায়ন সংস্থা : বিডব্লিউডিবি (BWDB)

দাতা সংস্থা : বিশ্ব ব্যাংক

কর্মক্ষেত্র (Working area):

Polder নাম	অবস্থান	দায়িত্বপ্রাপ্ত বিডব্লিউডিবি অফিস/অভিযোগ জমা দেওয়ার স্থান
৩৯/২C	ভান্ডারিয়া, পিরোজপুর	নির্বাহী প্রকৌশলী, বিডব্লিউডিবি, পিরোজপুর
৪০/২	পাথরঘাটা, বরগুনা	নির্বাহী প্রকৌশলী, বিডব্লিউডিবি, বরগুনা
৪১/১	সদর, বরগুনা	নির্বাহী প্রকৌশলী, বিডব্লিউডিবি, বরগুনা
৪৩/২C	গলাচিপা, পটুয়াখালী	নির্বাহী প্রকৌশলী, বিডব্লিউডিবি, পটুয়াখালী
৪৭/২	কলাপাড়া পটুয়াখালী	নির্বাহী প্রকৌশলী, বিডব্লিউডিবি, কলাপাড়া পটুয়াখালী
৪৮	কলাপাড়া পটুয়াখালী	নির্বাহী প্রকৌশলী, বিডব্লিউডিবি, কলাপাড়া পটুয়াখালী

অভিযোগ সমাধান কমিটি (GRC) :

১. নির্বাহী প্রকৌশলী (বিডব্লিউডিবি বিভাগের অফিস): আহ্বায়ক
২. এনজিও প্রতিনিধি: সদস্য-সচিব
৩. স্থানীয় ইউপি সদস্য/ওয়ার্ড কাউন্সিলর: সদস্য
৪. স্থানীয় শিক্ষা প্রতিষ্ঠান থেকে শিক্ষক (উপজেলা প্রশাসনের মনোনয়ন): সদস্য
৫. স্থানীয় মহিলা গ্রুপের প্রতিনিধি: সদস্য
৬. পিএপি গ্রুপ থেকে প্রতিনিধি: সদস্য

সামগ্রিক যোগাযোগ : প্রকল্প পরিচালক, সিইআইপি -1, বিডব্লিউডিবি, পানি ভবন, ঢাকা। Tel: 02-9899363; E-mail:

[pdpmuceip@gmail.com](mailto:pdpmuceip@gmail.com); Website: <http://www.ceip-bwdb.gov.bd>



# Coastal Embankment Improvement Project, Phase -1 (CEIP-1)

沿海堤防改善项目，第-1阶段（CEIP-1），包 W-02

## 申诉机制 (Grievance Redress Mechanism)

### 背景 (Background):

该项目的主要目标是：·减少自然灾害期间资产，作物和牲畜的损失；·减少飓风等自然灾害后的恢复时间；·通过减少由于气候变化而预计会恶化的咸水入侵来改善农业生产；·改善孟加拉国政府对符合条件的危机或紧急情况作出迅速有效反应的能力。·正在考虑 CEIP-1 的圩田中的现有堤防系统具有大约 10 年的回收期保护水平。堤防的现状使得在现有的薄弱环境中，一个超越事件可能导致堤坝发生灾难性的破坏 - 正如 Sidr 和 Aila 之后所见。·该项目的净面积约 100,817 公顷将受到保护，免受 2050 年气候变化条件下 25 年回归期的影响。通过考虑更高的沉降和海平面估计，还建立了其他安全因素。上升。项目完成后不久（例如 2022 年）的实际保护水平将超过 50 年的回收期。·通过建造路堤，排水调节器，冲洗水闸和圩田的排水渠道，增加净可耕地面积 86,362 公顷的农业产量。·通过减少由春季潮汐洪水和 Sidr&Aila 大小的气旋风暴潮造成的作物损害来提高作物产量。·通过建设冲洗入口，利用地表水，在综合灌溉网络下从当地切换到 HYV 水稻种植，以及·改善项目区现有的鱼类养殖，扩大 Boro 作物和 T-Aman 种植的排水系统。

项目实施期 (Project Implementation period): ২০১৩-২০২০।

执行机构 : BWDB

捐助机构 : 世界银行

工作区域 (Working area):

Polder 名	位置	负责的 BWDB 办公室/投诉地点
৩৯/২C	Bhanadria, Pirojpur	执行工程师, BWDB, Pirojpur
৪০/২	Pathorghata, Barguna	执行工程师, BWDB, Barguna
৪১/১	Barguna Sadar	执行工程师, BWDB, Barguna
৪৩/২C	Galachipa, Patuakhali	执行工程师, Galachipa, Patuakhali
৪৭/২	Kalapara, Patuakhali	执行工程师, Kalapara, Patuakhali
৪৮	Kalapara, Patuakhali	执行工程师, Kalapara, Patuakhali

申诉解决机制 (GRC) :

1. 执行工程师 (BWDB 分部办公室) : 召集人
2. 移民安置计划实施非政府组织的代表: 成员 - 秘书
3. 本地 UP 成员/ Ward 议员: 成员
4. 地方教育机构的教师 (由 Upazilla 管理局提名) : 成员
5. 当地妇女组的代表: 成员
6. PAP 集团代表: 成员

整体沟通: 项目总监, BWIP, CEIP-1, 帕尼巴班, 达卡。

Tel: 02-9899363; E-mail: [pdpmuceip@gmail.com](mailto:pdpmuceip@gmail.com); Website: <http://www.ceip-bwdb.gov.bd>

## Annex-13: Sample Record Keeping Forms

### Coastal Embankment Improvement Project, Phase-1 (CEIP-1)

Construction Monitoring Form (C-001)		
Title of the Form: Approval for Borrow area for Earth work/Embankment work		
Sl. No.	Item	Description
01.	Short Description of the activities	:
02.	Polder No	:
03.	Chainage of Embankment (for which borrow is required)	:
04.	Location of Borrow Pits (Mouza, Village, Police Station, District)	:
05.	Area of Borrow Pits	:
06.	Name and Address of the Land Owner	:
07.	Maximum Volume of Earth that can be excavated(in Cum)	:
08.	Payment (in Taka) for Borrowed Materials	:
(-----) Signature of Land Owner		(-----) Signature of Rep. from CICO

### Coastal Embankment Improvement Project, Phase-1 (CEIP-1)

Construction Monitoring Form (C-002)			
Title of the Form: Payment Slip for daily labour			
Sl. No.	Item		Description
01.	Polder No	:	
02.	Date of work	:	
03.	Place of work	:	
04.	Work done	:	
05.	Date of Payment	:	
06.	Amount Paid (in Fig.)	:	<div style="text-align: right;">(in Word: -----)</div>
(-----) Signature of receiver			(-----) Signature of Rep. of CICO

### Coastal Embankment Improvement Project, Phase-1 (CEIP-1)

Construction Monitoring Form (C-003)		
Title of the Form: Complaint Management Register		
Sl. No.	Item	Description
01.	Short Description of the task	:
02.	Type of Complaint (Administrative/Work related/Environment Related)	:
03.	Time and date of Complainant	:
04.	Response/Investigation done by	:
05.	Description of the action taken	:
06.	Designated persons for actions taken	:
(-----) Signature of EHS Supervisor		(-----) Signature of EHS in - Charge

### Coastal Embankment Improvement Project, Phase-1 (CEIP-1)

Construction Monitoring Form (C-004)		
Title of the Form: Accident Management Register		
Sl. No.	Item	Description
01.	Short Description of the activity	:
02.	Description of the accident	:
03.	Date and Time of Accident	:
04.	Type of Accident	:
05.	Response/Investigation done by Whom	:
06.	Finding of the Investigation Extent of damage i) property, ii) loss of lives	:
07.	Suggestive Mitigation Measures	:
08.	Person responsible for taking mitigation measures	:
(-----) Signature of EHS Manager		(-----) Signature of Polder manager (CICO)



**Coastal Embankment Improvement Project, Phase-1 (CEIP-1)**

<b>Construction Monitoring Form (C-007)</b>			
Title of the Form: Solid Waste Delivery Register			
Sl. No.	Item	:	Description
01.	Short Description of the activities	:	
02.	Description of the waste	:	
03.	Volume/Quantity of the waste	:	
04.	Waste taken by (Name and address)	:	
05.	Waste disposed by (Name and Designation)	:	
06.	Date of Disposal	:	
07.	Place of Disposal	:	
08.	Payment (in Taka) for disposal/income from vendors	:	
(-----) Signature of EHS manager			(-----) Signature of Polder Manager

## **Annex-14: Emergency Plan**

### **14.1 Scope**

The purpose of the Emergency Response Plan is to establish an organizational structure and procedures for response to major emergencies. It assigns the roles and responsibilities for the implementation of the plan during an emergency. This plan will cover emergencies arising within the work sites, transport and site offices.

#### **14.1.1 Hazard identification and controls**

Following hazards are considered for emergency plan

- Environmental issues
- Medical / health issues
- Fire
- Accidents (in construction site or during transportation or in camps)
- Utility or service failure, and
- Security breaches.

#### **14.1.2 Emergency team**

For each type of emergency a response team will be prepared and trained. Each member of the workforce will be trained to report to his/her superior if sees an emergency. The supervisor will immediately contact the core response team for appropriate measures.

#### **14.1.3 Communication and coordinaiton**

Communication can be done with signals/ sirens / cell phones according to the necessity and the nature of the emergency.

List of persons to be contacted are presented in the following pages.

#### **14.1.4 Training**

Staffs will be trained so that they can identify and act in case of an emergency. Drills will be done periodically to test the effeiciency of people and the equipment.

#### **14.1.5 Accident/incident review**

After any emergency situation, the management will review the accident/incident to find the cause of the situation and will try to find out measures to prevent such incident in future. The review meeting will also find out whether the response to this incident were carried out



according to the existing emergency plan and if there is a more efficient way to respond to such situation. This will be done within 2 weeks after the incident. The findings will be reported and will be implemented appropriately.

#### **14.1.6 Plan review**

The emergency plan will be reviewed to incorporate any measures which are suggested by the managements' Accident/incident review meeting. The plan will be updated within 1 month after getting the suggestion on corrective measures.

#### **14.1. 7 Covid-19 response in Package 2 areas**

The evolving of COVID-19 pandemic in Bangladesh compelled both the contractor of Package-1 and 2 for maintaining covid-19 management at each site. From the beginning of Corona virus infection in Bangladesh the Contractor was very much aware of implementation of the instructions mentioned in OHS protocol of construction sites for protection of their work force against COVID-19 infection. They have maintained consultation with PMU, who has the overall accountability of the OHS governance and assurance of the project. The Contractor erected various pictorial signboards at all worksites displaying how various practices related to control of COVID-19 to be adopted by the work force. Moreover, they have trained the workers on how to remain safe/unaffected from the attack of COVID-19 and what measures to be followed in case of any infection of COVID-19, following the COVID-19 OHS protocols and other instructions from the local National Health Departments. The Contractor has also maintained constant communication with the various clinics/hospitals to face any incidence of COVID-19 infection.

Major other steps undertaken by the Contractor, following the COVID-19 OHS Protocols are as follows:

1. The Contractor developed a plan for COVID-19 pandemic to address the exposure risk, routes of transmission of workers in advance as possible of potentially worsening outbreak conditions.
2. Appointed Covid-19 Site coordinator, responsible for all control measures related to COVID-19 prevention.
3. Informed/trained/supervised employees with updated and usual health and updated preventive recommendations that have to be followed individually and collectively.
4. Provided workers with the COVID-19 related Personal Protective Equipment (COVID-PPE) according to local health authority that included face mask, face shields or glasses, hand sanitizers and others required.
5. Avoided physical gathering and non-essential meeting and made arrangement for maintaining distance (2 meters) for individual work force working at site.
6. Measuring body temperature of workforce every day at inception of work.

7. Make arrangement for hand cleaning by use of approved hand sanitizers/soap by the workforce at number of times to avoid infection/spreading of virus
8. Provision of PPE like surgical masks, medical gloves, eye mask to supporting staff (such as gate guard, police)
9. Provide quarantine facilities at all camp sites
10. Thorough disinfection drive carried out on weekly holiday in all work sites like office areas, camps, prefabrication plants/workshop, construction vehicles. Equipment, motor vehicles etc.
11. Workers are not allowed any leave during work period and leaving work site is forbidden
12. Workers were encouraged to get vaccinated for all the 3 courses as approved by the National Health Department
13. Carried out routine testing of the workforce for potential COVID-19 infection
14. Workers were asked to notify with immediate action to their supervisors, if feeling ill, sick or unwell.
15. Made arrangement for adoption of required measures whenever any worker gets infected.

(To be finalized later on and approval to be taken from the authority)

EMERGENCY RESPONSE PLAN

For:

Facility Name: Polder No 40/2

Facility Address: Barguna

DATE PREPARED: \_\_/\_\_/\_\_\_\_

## 14.2 SEVERE WEATHER AND NATURAL DISASTERS

### ***Cyclone***

- When a warning is issued by sirens or other means, seek inside shelter. Consider the following:
  - Small interior rooms on the lowest floor and without windows,
  - Hallways on the lowest floor away from doors and windows, and
  - Rooms constructed with reinforced concrete, brick, or block with no windows.
- Stay away from outside walls and windows.
- Use arms to protect head and neck.
- Remain sheltered until the tornado threat is announced to be over.

### ***Earthquake:***

- Stay calm and await instructions from the Emergency Coordinator or the designated official.
- Gather at the marked earthquake safe point (reinforced concrete areas)
- Keep away from overhead fixtures, windows, filing cabinets, and electrical power.
- Assist people with disabilities in finding a safe place.
- Evacuate as instructed by the Emergency Coordinator and/or the designated official.

### ***Flood:***

#### *If indoors:*

- Be ready to evacuate as directed by the Emergency Coordinator and/or the designated official.
- Follow the recommended primary or secondary evacuation routes.

#### *If outdoors:*

- Climb to high ground and stay there.
- Avoid walking or driving through flood water.
- If car stalls, abandon it immediately and climb to a higher ground.

## **Management or Emergency Response against severe weather and Natural Calamities/hazards**

- **Structural and Non- Structural Mitigation**
  - C. Based on the new concept of disaster management, both structural as well as non-structural mitigation measures will be taken keeping in view the aspect of better coordination within overall disaster management system.
  
- **Institutional arrangement**
  - D. CICO will be taken a number of significant steps for building up institutional arrangements from national to site levels for effective and systematic disaster management facilitating mitigation to the sufferings of disaster victims.
  
- **Emergency preparedness**

CICO will be taken a number of significant steps to build up institutional arrangement from national to the union levels for effective and systematic disaster preparedness in construction sites. These are:

  - I. Formation of Disaster Management Team.
  - II. Liaison with the existing Govt. and NGOs team.
  
- **Emergency Response**
  - I. Achieved the first information of the disaster emergency situation and works on the overall direction for handling all aspects of emergency situation.
  - II. Strictly handling the overall situations.
  - III. Providing technical supports regarding minimization the losses.
  - IV. Quickly Shifted in Safe place.
  - V. Cyclone Preparedness Program (CPP) which plays very useful role during cyclone.
  
- **Disaster Management Mechanism**
  - I. Assuring the Standing Orders to handle emergency situations efficiently.
  - II. The initial operational direction and co-ordination with existing Committee.
  - III. Preparing and protecting people at field levels and increasing their capacities to cope with and recover from disasters.

### 14.3 EMERGENCY PERSONNEL NAMES AND PHONE NUMBERS

DESIGNATED RESPONSIBLE OFFICIAL:

Name: **(Li Zhengdao, Polder Manager-40/2)**

Phone: **(01645649516)**

EMERGENCY COORDINATOR:

Name: **(Bu Shidong, Chinese EHS Manager)**. He is assigned as responsible Officer for implementing emergency response plan.

Phone: **(01739824919)**

ASSISTANTS TO PHYSICALLY CHALLENGED (If applicable):

Name: ( \_\_\_\_\_ )

Phone: ( \_\_\_\_\_ )

Date:

## **14.4 EVACUATION ROUTES**

Evacuation route maps have been posted in each work area. The following information is marked on evacuation maps:

Emergency exits

Primary and secondary evacuation routes

Locations of fire extinguishers

Location of Fire alarm switch

- a. Assembly points
- Site personnel should know at least two evacuation routes.

## 14.4 EMERGENCY PHONE NUMBERS

**(Shall be displayed at the base camp and prime location of the Project)**

FIRE DEPARTMENT: Barguna Fire Station 01712-437927

NEARBY HOSPITAL: Patharghata Upazila Health and Family Planning Office 01717-880655

AMBULANCE:

POLICE:

(ii) Superintending of Police 01713-374347

(i) Officer in Charge, 01713-374355

FIRE BRIGADE AND CIVIL DEFENCE: 199



## **14.6 UTILITY COMPANY EMERGENCY CONTACTS**

**ELECTRIC:** Imran Talukder 01711367338

**WATER:** Baher 01718249677

**GAS (if applicable):** Imran Talukder 01711367338

**TELEPHONE COMPANY:** 044862211

Date: 27/11/2017

## 14.7 EMERGENCY REPORTING AND EVACUATION PROCEDURES

Types of emergencies to be reported by site personnel to its project managers are:

- MEDICAL
- FIRE
- SEVERE WEATHER
- EXTENDED POWER LOSS
- OTHER (specify)\_\_\_\_\_

(e.g., terrorist attack/hostage taking)

## 14.8 MEDICAL EMERGENCY

- Call medical emergency phone number (check applicable):

Paramedics

Ambulance

Fire Department

Other

Record Name/details of the patient

Provide the following information:

- a. Nature of medical emergency,
  - b. Location of the emergency (address, building, room number), and
  - c. Your name and phone number from which you are calling.
- Do not move victim unless absolutely necessary.
  - Call the following personnel trained in CPR and First Aid to provide the required assistance prior to the arrival of the professional medical help:

Name: Phone: \_\_\_\_\_

Name: Phone: \_\_\_\_\_

Date \_\_\_/\_\_\_/\_\_\_

## 14.9 FIRE EMERGENCY

*When fire is discovered:*

- Activate the nearest fire alarm (if installed)
- Notify the local Fire Department over phone.
- If the fire alarm is not available, notify the site personnel about the fire emergency by the following means (check applicable):

Voice Communication

Phone Paging

Radio

Other (specify)

*Fight the fire ONLY if:*

- The Fire Department has been notified.
- The fire is small and is not spreading to other areas.
- Escaping the area is possible by backing up to the nearest exit.
- The fire extinguisher is in working condition and personnel are trained to use it.

*Upon being notified about the fire emergency, occupants must:*

- Leave the building using the designated escape routes.
- Assemble in the designated area (specify location):
- Remain outside until the competent authority (Designated Official or designee) announces that it is safe to re-enter.

*Designated Official, Emergency Coordinator or supervisors must (underline one):*

- Disconnect utilities and equipment unless doing so jeopardizes his/her safety.
- Coordinate an orderly evacuation of personnel.
- Perform an accurate head count of personnel reported to the designated area.
- Determine a rescue method to locate missing personnel.
- Provide the Fire Department personnel with the necessary information about the facility.
- Perform assessment and coordinate weather forecast office emergency closing procedures

Date \_\_\_/\_\_\_/\_\_\_

#### **14. 10 EXTENDED POWER LOSS**

In the event of extended power loss to a facility certain precautionary measures should be taken depending on the geographical location and environment of the facility:

Unnecessary electrical equipment and appliances should be turned off in the event that power restoration surge would cause damage to electronics and effecting sensitive equipment.

##### Upon Restoration of power:

Electronic equipment should be brought up to ambient temperatures before energizing to prevent condensate from forming on circuitry.

Fire and potable water piping should be checked for leaks after the power has been restored to the facility and water turned back on.

# Annex-15: Layout plan for fuel storage

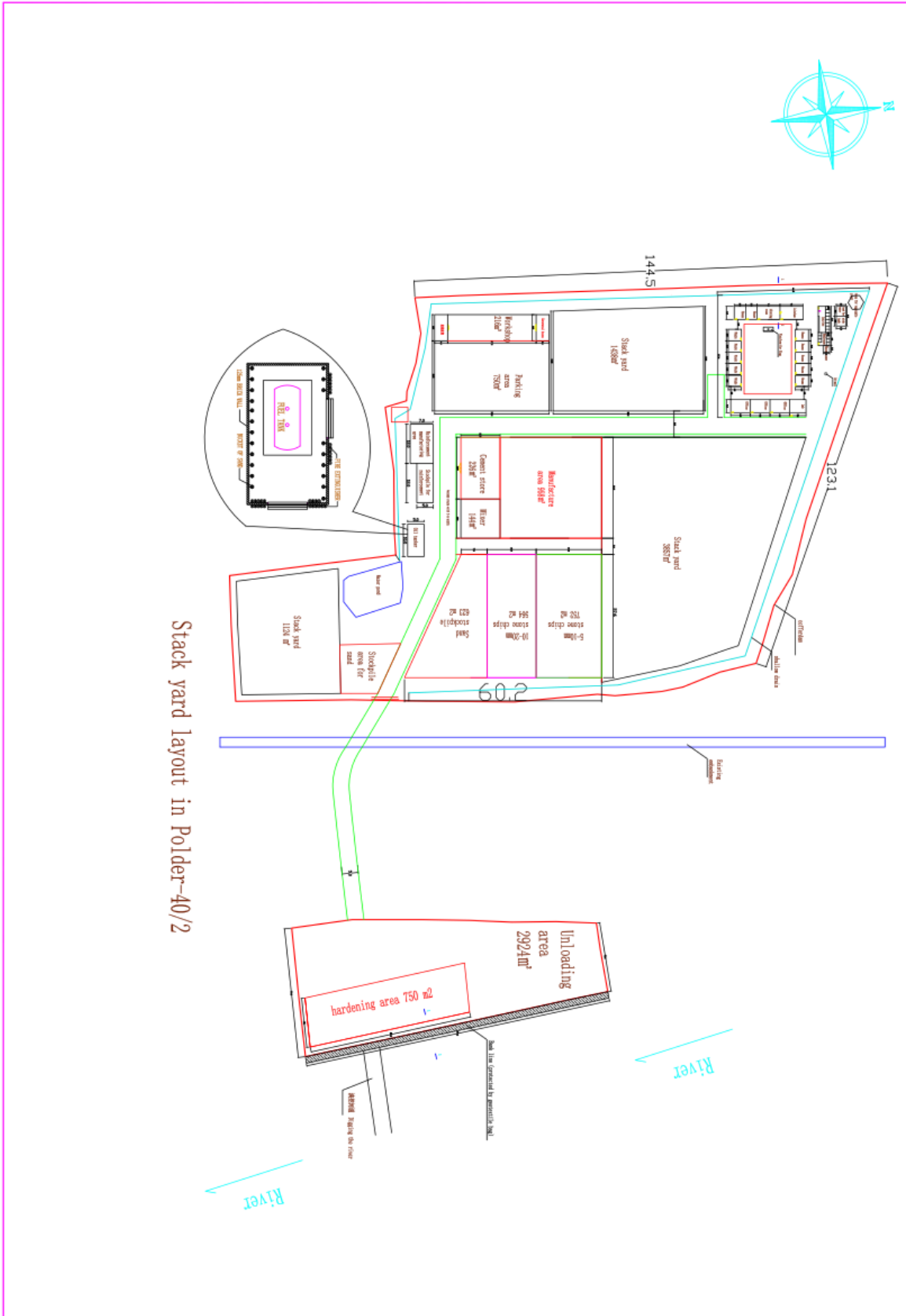

Stack yard layout in Polder-40/2

## Annex-16: Layout plan for construction camp's wastewater management

(To be finalized before starting the physical work, flow diagram is attached in annex 16)

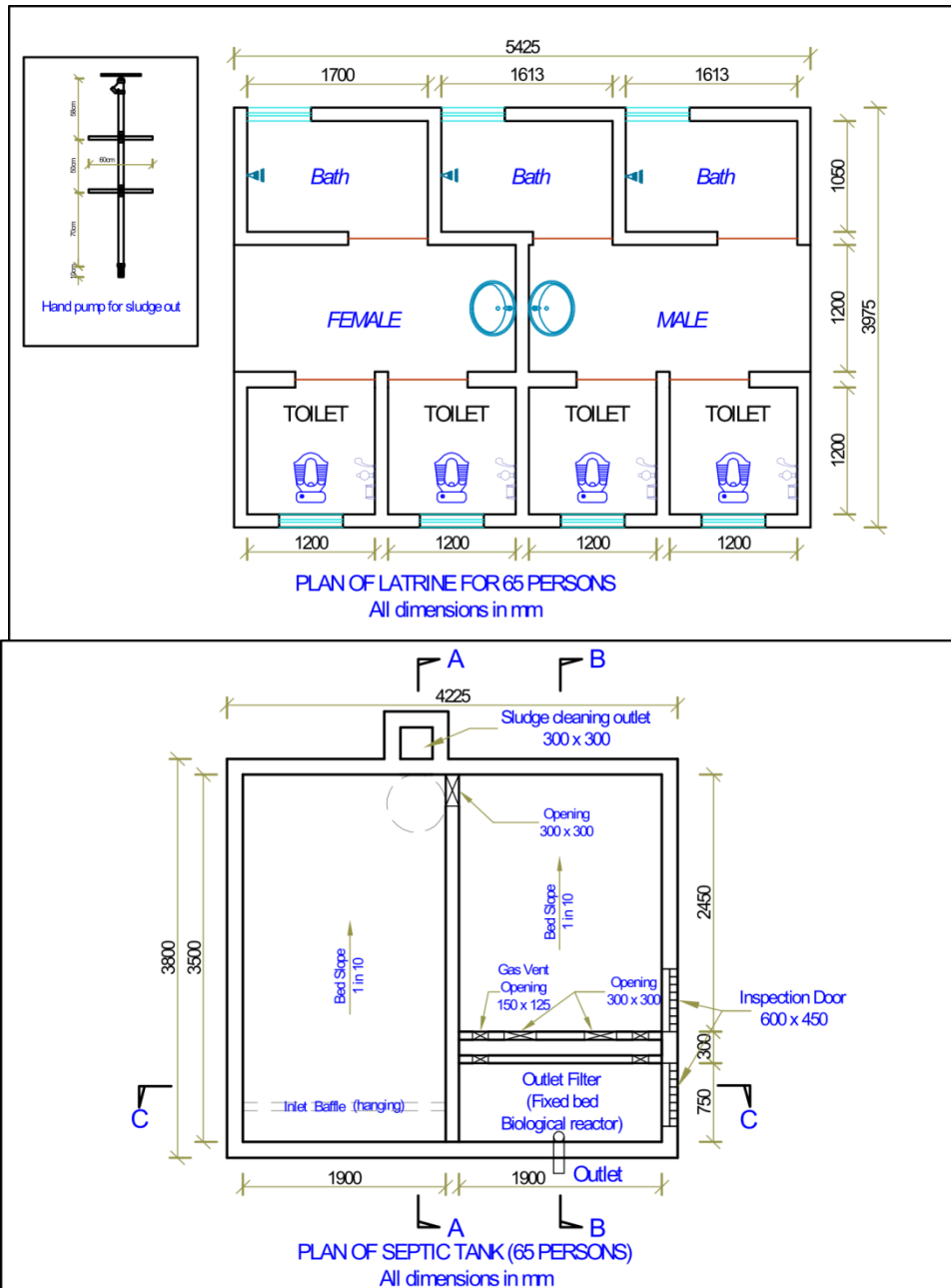



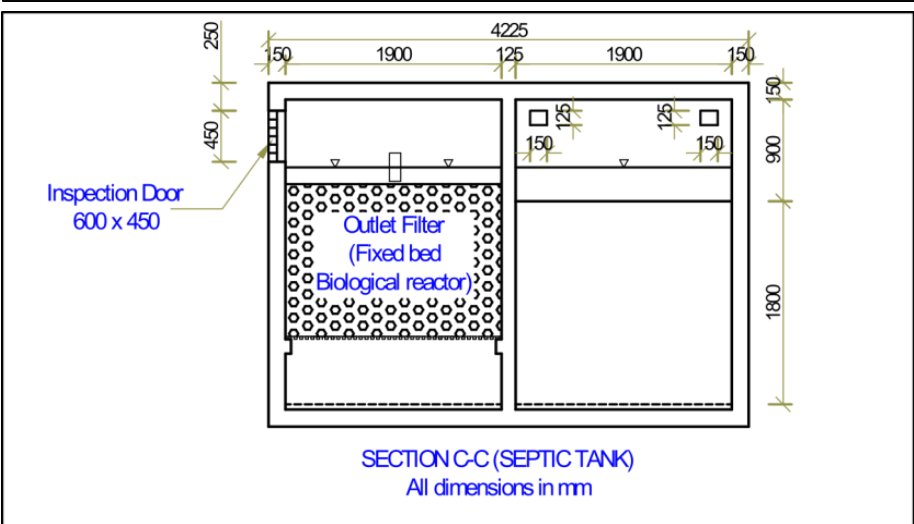
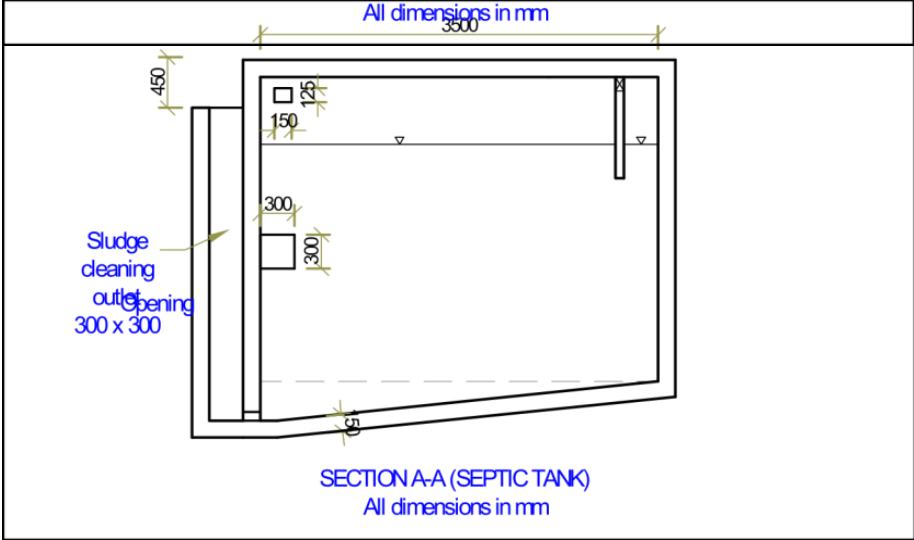
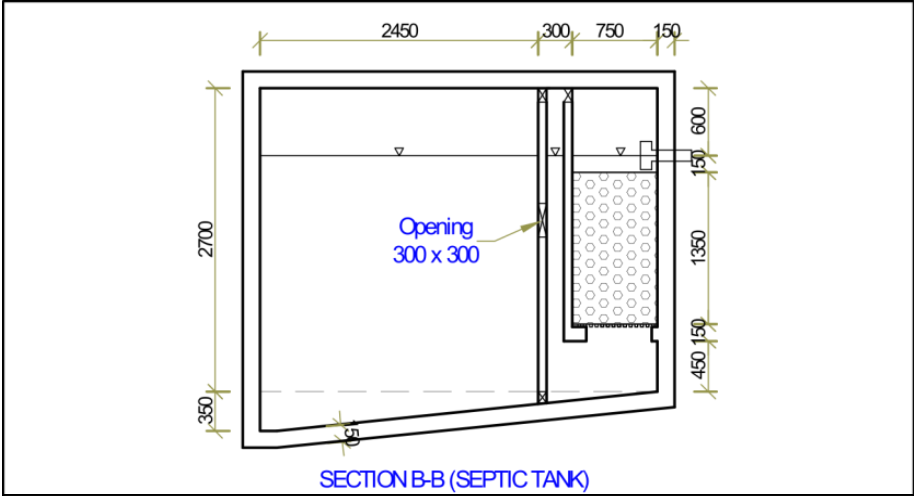

## Annex-17: Flow diagram for waste management

(To be finalized before starting the physical work)

### 1. Solid waste disposal from labor shed and office sites.

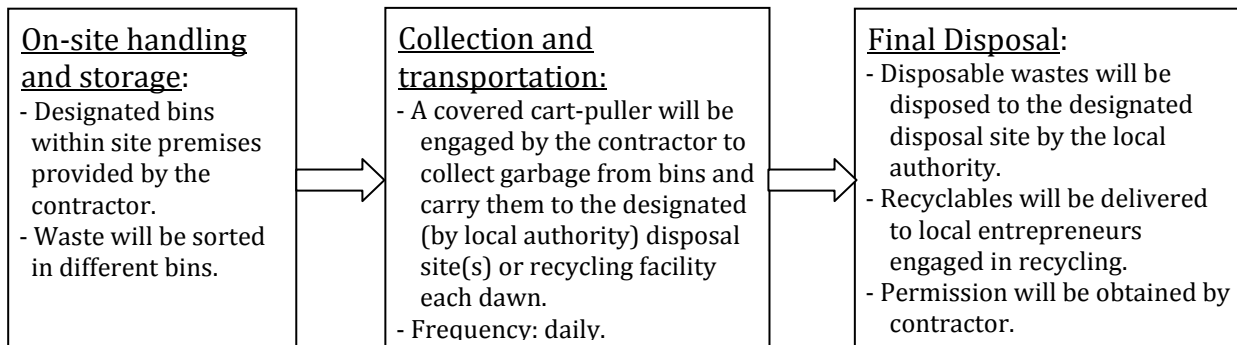

### 2. Inert Solid waste from construction site

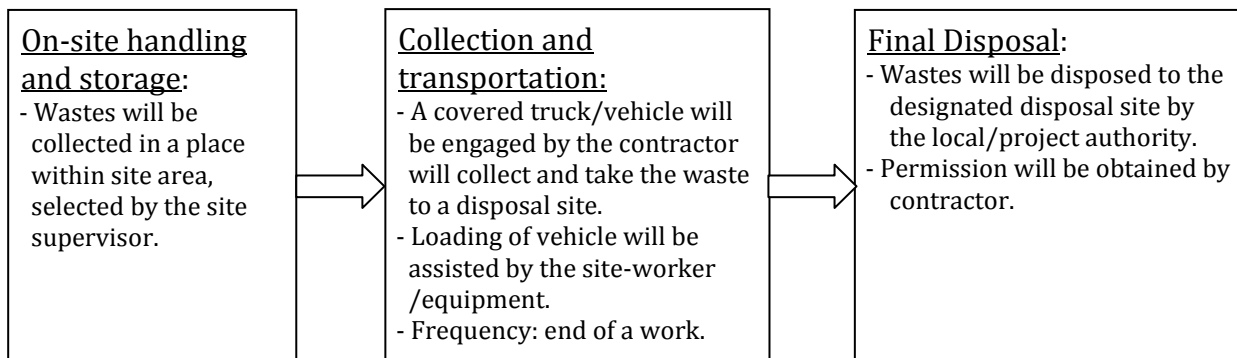

### 3. Oil and grease from construction site

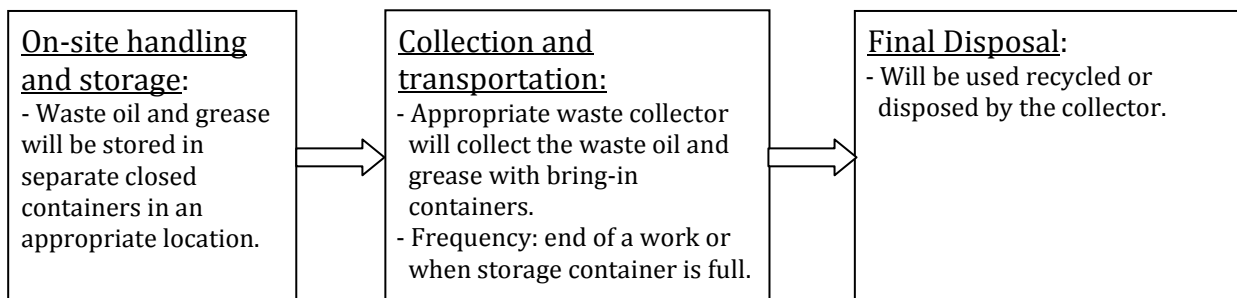

### 4. Chemical waste from construction site

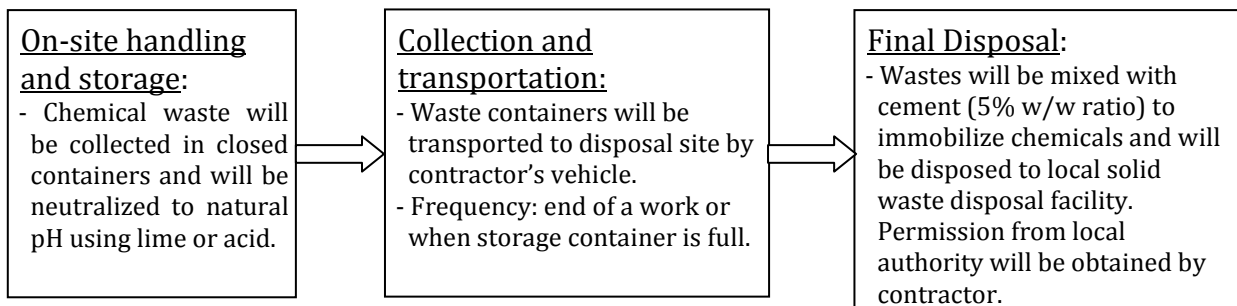

\*\* For each site, the site Local EHS officer will maintain a register for waste delivery truck/cart to record the time and amount (by approximate % volume of the vehicle/container capacity) of waste going out.

## Annex-18: Hazard and Incident Reporting and Investigation Procedure

### 1. Purpose:

The purpose of this Procedure is to describe the hazard and incident reporting, management and investigation process.

### 2. Scope:

This procedure applies to all workplaces including base camps and regional offices.

### 3. Procedure:

#### Reporting on EHS Department

All CICO employees are responsible for reporting all hazards, incidents and near misses via EHS department of CICO. Contractors, workers and visitors should report hazards, incidents or near misses to their site contact/site supervisor (who should then report the incident or hazard onto EHS). Hazards, incidents and near misses should be reported as soon as practicable.

#### Reporting hazards

The **Workplace Manager** and/or **Management EHS Nominee** are to ensure identified hazards are reported onto Manager EHS. Minor hazards (e.g. torn carpet) do not need to be reported EHS manager.

#### Reporting Incidents

The **Workplace Manager** and/or **Management EHS Nominee** are to ensure all incidents involving employees, volunteer workers, visitors, contractors and members of the public are reported onto EHS Manager. This includes employee or volunteer worker related incidents that occur both on and off CICO premises.

#### Action and closing out reports

The EHS Manager in consultation with the affected person(s) & nominated EHS personnel in the field/ work supervisors are to close out the incident report by developing and implementing an 'action plan' to address the hazard or incident in order to manage the risk and to prevent a reoccurrence.

## Reporting Employee injuries/incidents

The **Workplace Manager** and/or **Management OHS Nominee** are to ensure all employees related incidents are reported in a local injury register. The following incidents/injuries must be reported on:

- strains/sprains
- lacerations/cuts
- burns/scalds
- crushing/amputations
- bruises/knocks
- Death.

## Reporting to the Security Services Unit

The **Workplace Manager** and/or **Management EHS Nominee** are to report immediately all serious incidents to the Security Services and concerned officers the authority (PMU, DDCS & PMSCs). Examples include:

- death or serious injury to employee or visitor
- fire, flood, storm or earthquake incidents
- assault
- theft or vandalism.

## Conducting an incident investigation

The **Workplace Manager** and/or **Management EHS Nominee** are to conduct a formal incident investigation within 24 hours of the notifiable incident, where possible, using the standard format approved by the authority (PMU, DDCS & PMSCs).

The **EHS Manager** may convene an incident investigation team comprising management, affected employee and other employees, depending on the nature of the incident. The investigation should seek to identify the causes and any potential hazards, and provide recommended control and preventative measures.

Upon completion of the investigation, the **EHS Manager** should implement the recommended risk controls and communicate outcomes of the investigation to all employees. The EHS Risk Register should also be reviewed and updated if necessary.

## Record keeping

The **Workplace EHS Manager** must maintain copies of all documentation used as part of the hazard and incident investigation and control process. Documentation associated with any hazard or incident should be retained till the end of the project.

## Annex-19: H&S Plan Draft set-up

Note:

This Health and Safety Plan (H&S Plan) is an Annex to the Contractor Environmental and Social Management Plan (C- ESMP) and should be read in conjunction with this C- ESMP in order to understand Project background, organizational set-up, etc. Cross-references have been made to specific sections in this C-ESMP where appropriate.

### Introduction

This H&S Plan was drafted to enable the safe execution of the Works in compliance with legislative and Client requirements. For this the hazards associated with the various tasks/works have been identified and analyzed. Following hazard assessment, possible remedial measures are defined for situations of excessive risk. A hierarchy of control measures to eliminate or minimize the risk follows the following order of priority:

Firstly, try to **eliminate** the hazard. If this is not possible, **prevent or minimise exposure to the risk** by one or a combination of:

- a. Substituting a less hazardous material, process or equipment
- b. Redesigning equipment or work processes
- o Isolating the hazard
- c. (Note: These measures may include engineering methods)

As a last resort, when exposure to the risk is not (or cannot be) minimized by other means:

- d. Introduce administrative controls (limit entry, training, warning signs, etc.)
- e. Use appropriate Personal Protective Equipment (PPE)

### Planning

The Project Manager, in conjunction with the project team and HSE Manager, will ensure the following:

- Perform a risk assessment of the Works
- Review the adequacy of safety documentation
- Develop a program for the implementation of health & safety controls
- Identification and acquisition of any controls, processes and equipment
- Implement a system of identification and filing of health & safety records
- The Project Manager shall ensure these proceedings are documented and nominated activities are performed and completed in a timely manner
- That employees consider hazards and plan work accordingly to ensure that it is carried out safely.

## **Project organisation**

The project organization is included in Section 6 of this C-ESMP.

## **Training**

The goal of health and safety training is to provide a mechanism for staff to understand health and safety hazards, and how to protect themselves and others. Safety and health training programmes include determining the training needs, involving staff in the programme design and implementing the training. All training will be recorded (see Section 6 for specifics about training). Training subjects are among others:

- Project Safety Plan/Potential Hazards
- First Aid
- Fire provisions
- Emergency procedures
- Personal protective equipment
- Security
- General responsibilities of employees
- Environmental Aspects and Impacts
- Incident Reporting Procedure
- An additional separate induction will be provided on HIV/AIDS prevention and control awareness.

## **Communication**

See Annex-18 for relevant procedures on communication

## **Documentation**

See Section 7 and Annex-18 for relevant procedures on documentation

The hazard assessment will be conducted prior to the Works commencing to establish potential risks and hazards inherent within the environment and scope of the project.

Draft H&S plan set-up has refreshed addressing the risk/hazard assessment and comprehensive mitigation measures for OHS, CC block plants other sites of Health and Safety issues.

When Works change over time, hazard assessments will be executed for these (parts) of the Works again. Supervisors will correct and reinforce safe and healthy work practices as part of their daily routine. During execution of the Works regular inspections and audits will be carried out. The hazards identified during these inspections will be recorded. Also, if any incident happens, an investigation will be executed and the causes identified. These hazards and causes will be included in the risk assessment process during revision of the risk assessments.

## **Risk Assessment and control**

This section details the safety system practices to provide an acceptable standard of safety on the Project

### ***HOUSEKEEPING***

Housekeeping is to be considered an extension of every activity on the project. Good housekeeping practices contribute to the prevention of injuries and have a positive impact on the overall project health and safety.

Supervisors shall be responsible for ensuring that:

- Work areas within their control are maintained in a tidy and safe manner
- That materials and equipment not in use are neatly stored away from work area and clear of access ways
- All office, housing and toilet facilities are to be cleaned daily
- Common paths of travel are established and are kept free from debris or the accumulation of materials
- Access to aisles, exits and emergency equipment are free from any obstruction
- Specific areas are designated for the storage of materials
- Tools, equipment and materials are stored in an orderly manner
- All spills shall be quickly cleaned up

### ***FIRST AID MANAGEMENT***

- Persons at work should receive prompt first aid treatment in case of injury or emergency.
- A first aid box or boxes at or near the workplace shall be available and accessible.
- A first aid box should contain suitable first aid equipment which is regularly checked and restocked.
- A notice or sign in a visible place at a workplace should indicate where the first aid box or boxes are kept.

### ***EMERGENCY PREPAREDNESS AND RESPONSE***

Refer to the Emergency Preparedness and Response Plan as attached (Annex 14). The Emergency Contacts and the emergency contact numbers should be available at each Project site.

## **TRAFFIC**

Traffic pressure is low in the project area but roads are few and not well maintained and narrow. Mixing with work traffic is inescapable, especially at work sites where bypass roads have to be constructed.

Control measures are:

- Development of Traffic Management Plans for the relevant Work sites
- No night-driving
- All vehicles and equipment shall have regular services and must be inspected prior to mobilization
- All vehicles must be fitted with a fire extinguisher
- All vehicle drivers shall be competent and provide proof of a relevant and valid driver's license upon request
- Overloading of vehicles is forbidden

## **PLANT & EQUIPMENT CONTROL**

The typical types of plant used on this project are:

- Vessels and barges
- Excavators, dump trucks etc.
- Lifting equipment (winches/cranes/riggings, etc.)
- Compressors, generators, welding equipment
- Stone crushers, Concrete mixing machines

Control measures are:

- A register, maintained for all major plants (name, model, registration & serial number, manufacturer and year of manufacture, certification status)
- Each plant is equipped with approved fire extinguisher
- Personnel are qualified to operate the plant
- Loading ratings on plant are within specified limits to prevent overloading
- Plant is operated
- Under the supervision of a competent and authorized person
- In accordance with manufacturer's/owner's requirements

## **ELECTRICAL EQUIPMENT SHOULD BE:**

- Clearly marked that it has double or reinforced insulation
- Maintained, together with its flexible cord and plug, in a serviceable condition, be inspected and tagged by a qualified electrician prior to their first use and thereafter at monthly intervals



## **FIRE PREVENTION AND CONTROL MEASURES**

- Firefighting equipment will be provided in all site offices, construction sites, sheds and storage areas
- Portable firefighting equipments shall be provided on all moving plant on the site
- All fire extinguishers are to be checked by a competent person on a six (6) monthly basis and a register of inspections kept by the Project Safety Representative
- Smoking will be prohibited in work areas identified and signposted as hazardous areas

## **WORKING AT HEIGHTS**

Persons working at heights shall have adequate supervision and be issued with instruction to ensure safe work practices are observed. All work at height shall have:

- Scaffolding with hand rails
- Elevated work platforms
- Safety harness and static line or appropriate anchorage
- Personnel required working over water should wear appropriate floatation devices

## **HOT WORK**

Hot work includes all forms of welding, oxy acetylene cutting, grinding or cutting using abrasive tools. Control measures are:

- Persons undertaking Hot Work must be qualified to do so.
- Provision of proper eye protection such as welder goggles and/or a full-face eye shield for all personnel involved in, or assisting, welding operations.
- Additional methods may include the use of welding barrier screens around the specific work station (a solid piece of light metal, canvas, or plywood signed to block welding light from others).

## **CHECKING AND CORRECTIVE ACTION**

- All the activities will be monitored using the checklists attached.
- Nevertheless the Health and Safety Manager/Officer shall do a weekly inspection to ensure the conformity of the Project,
- Where non-compliance is reflected, corrective and preventive measures should follow.
- Records of the evaluation will be kept to show continual improvement and commitment to compliance.

## **HEAT STROKE**

### **Premonitory heat stroke**

(1) Rescue immediately through separate the patient away from hyperthermia condition, bring the patients to the place with good ventilation for rest, unbutton the clothes and waist belt of the patient, rip open or take off the patient's clothes.

(2) Organize mutual rescue. Give cooler salty drink to patient and anti- heat stroke medicine such as Camphoradin, Jintan, Ageratum-liquid, etc.

Massage shall not be adopted when the patient has a muscle cramps, otherwise it will increase the pain to the patient. Salts and calcium shall be given to the patient as soon as possible for humoral supplement.

Dial the emergency call for help and at the same time carry out the above said procedures when the patient present to be circulatory failure. Cooperate with the medical staffs to carry out emergency rescue and transfer the wounded to hospital as soon as possible.

### **Severe heat stroke**

(1) Rescue immediately through separate the patient away from hyperthermia condition, bring the patients to the place with good ventilation for rest, unbutton the clothes and waist belt of the patient, rip open or take off the patient's clothes.

(2) Organize mutual rescue, take various cooling measures rapidly, the measures are as follows:

① Water bath method: immerge the patient in to water except the head so as to enable the heat to be absorbed by cooling water, but this not apply to the extremely serious, comatose, shocked, heart failure patient.

② Transfer the patient into the Air-conditioned room with temperature about 25°C, place ice-bags near main artery of his/her head, neck, neck sides, armpit, groin and wash his/her body by using icy water, continuously rub his/her skin to make it red to prevent hypostasis occur.

③ Sprinkling icy water and/or placing ice cubes in the room and fans shall be adopted when air-condition is not available. At the same time, wash the whole body by using well water and cover the body by wet towel to accelerate hypothermy.

While performing the above-mentioned steps, the medical emergency aid 120 is assisted. To assist 120 to carry out medical emergency work, quickly sent to the hospital for treatment of the wounded.

Dial the emergency call for help and at the same time carry out the above said procedures when the patient present to be circulatory failure. Cooperate with the medical staffs to carry out emergency rescue and transfer the wounded to hospital as soon as possible.

## **ENVIRONMENTAL MANAGEMENT AND CONTROL MEASURES IN CC BLOCK MANUFACTURING YARD**

## Manufacture of pre-cast CC blocks

The mitigation of the followings will be implemented fulfilling other environmental obligations during the Project which rests with the Project Director (PD). All mitigation measures proposed in EHS Risk Assessment will be implemented under the institutional arrangement proposed in EAP that include - the Contractor will implement the EHS Risk assessment and it would be monitored by the Environmental Specialists of PMU, DDSCS&PMSC and third party M&E Consultants as proposed in EAP.

- Signals will be installed to indicate the entry and exits and movement of vehicles in the work area.
- Workers will be equipped with proper PPE.
- A flagman should be appointed to regulate movement of vehicles, workers and visitors along with their safety.
- Forklift Operation Safety manual will be ensured in the site
- Separate operators' room within the CC plant will be ensured to minimize the noise exposure to the operator
- Generally, the manufacturing will take place at day time; it can only take place at night with proper environmental protective measurement.
- Stacks with sand will be covered or wetted
- Water spraying will be ensured in the yard and its surrounding areas to control dusts.
- Stacking to be done sensibly so that the stacked CC blocks do not collapse causing accident
- Worksite hazard assessment form/register to be kept updated
- Noise meter to be installed to monitor noise
- Checking and maintenance of the electrical wires, other electrical connections, components to avoid any fire or accident.
- Firefighting facility will be available and workers will have demo practices
- Use proper PPEs while welding, emergency kits to be handy, if needed.

## DUST CONTROL

(1) Dust discharging shall follow the standard that not to endanger the operating personnel health.

(2) Measures of dust control

① The cement shall be stored in a sealed warehouse, workers for transportation shall wear dustproof mask, and transportation shall be carried out in gentle so as to prevent from forming dust.

② For sand and aggregate stacking yard, materials shall be stored in stipulated area as per the civilized construction. Covers shall be adopted to prevent dust from forming on basis of the various weather conditions.

③ Dust disposal methods for operating activities:

i ) For the dust pollution of the batching equipment operation, dustproof cover shall be installed firstly in shed with good ventilation condition, batching equipment shall be fixed properly, and workers shall wear dustproof masks and operate the equipment in upwind direction.

ii ) When clearing up the site after the construction finished, bagging-off the big-sized first, then sweep and sprinkle water to prevent from forming dust, the sweeper shall wear dustproof mask. Vacuum cleaner shall be adopted for the powder dust, and then cleaned by water.

iii) Operators/Workers shall wear dustproof masks in closed rooms when doing the grinding process of the coating work. Prevent the dust from spreading by the method of one room grinded, one room sealed.

iv ) During the demolition process, things removed cannot be littered, unified by an export transport, to take chute or bag transport, to prevent the removal of objects falling down caused by dust.

During dismantling work, components removed shall not to be thrown optional, and shall be transferred in one-unit outlet via adoption of slots or bags, so as to ensure there is no dust formed by the compaction of the dismantled parts.

v ) Oxygen cutting and welding work shall be carried out in an open field, ventilation measures and dustproof mask shall be adopted when such work is carried out in closed room or basement where ventilation is not so good.

vi ) For area of vehicles transportation which is easy to form dust, speed limit area shall be set up first, then specialist shall be arranged to sweep and sprinkle water regularly.

vii) For sieving of sand and aggregate, no such work is allowed to carry out during the strong wind, operators shall be upwind when carrying out such work in normal weather conditions.

(3) The full-time safety supervisor, civilized construction management staffs and safety construction supervisor of labor union shall supervise the place where the dust formed and follow the related activities, make record of this, find out the potential factors, issue the rectification notice and push the site staffs to implement the rectify.

(4) The Quality Control (QC) department under the leadership of Project Office, shall carry out the supervision and inspection of the dust management, issue the rectification notice with the signature of the Project Manager when problem is found, feedback the rectification results to the Project Manager in time.

## **NOISE CONTROL**

(1) Source of pollution: High decibel noise may occur during installation or operation of large and/or medium-sized machinery; installation and removal of scaffolding and protective sheds, transportation and stacking of formwork, material and equipment, and when using other mini type machinery.

(2) Mechanical equipment, noise control

① Maintenance to the excavation, transportation equipment of various pile construction shall be carried out prior to the construction in accordance with the stipulation of maintenance. All troubles of the equipment found during construction shall be debugged in time so as not to working with troubles.

② Large-scale equipment set up on site such as tower crane, construction elevator, concrete pump and concrete batching plant shall be checked/inspected and shall be used only the checking/inspection result qualified. During operating, operators shall clean, lubricate, maintenance the parts of the equipment in order to reduce the possibility of emitting noise.

③ For small and medium-sized mechanical equipment which may emit large noise, it should be checked and identified before use, used for normal maintenance and maintenance. If necessary, special noise control measures should be taken for the equipment, such as equipment, Device protective cover, try to use environmentally friendly machinery and equipment.

For the mini-type and medium-type equipment which may emit big noise, inspection and normal maintenance shall be done prior to use. Special noise control measures such as soundproof sheds and protective cover for rotating device shall be adopted when necessary.

④ Service time, frequency, and quantities shall be strictly controlled when using mini power tools such as electric-pick, portable electric saw, etc. Such work shall be carried out as less as possible at night.

⑤ **Noise control of construction**

i ) Noise from construction shall be strictly controlled. Activities such as erecting and dismantling machinery equipment and formwork, installing scaffolding and reinforcement, batching concrete shall be carried out in daytime on basis of the degree of noise.

ii ) In the tower crane, construction elevator, concrete mixing station installation, removal, to control the construction time, spare parts, tools placed lightly to minimize the impact of metal parts, not from the higher metal parts, so as not to a larger sound.

Construction time shall be well arranged when erecting, dismantling the tower crane, construction elevator, concrete batching plant. Accessories and tools shall be handled with care in order to reduce the impaction of metal parts. No high throw of metal parts is allowed which will cause big noise.

iii ) Procedure shall be followed strictly when installing/dismantling scaffold and various types of metal gratings by using components such as steel pipe and steel frame. No high throw of steel pipe, fastener and other components is allowed, especially during the dismantling.

iv ) Sound from impaction during transport, install, remove the formwork and bending, installing reinforcement shall be limited when constructing structures. Construction shall be carried out as per requirement of the noise control measures. No optional knocking of steel formwork and reinforcement, no free falling or throwing from high when removing the formwork.

v ) Construction shall be carried out as per the procedure when vibrating the concrete, environment friendly vibrators shall be adopted when necessary so as to limit the harsh sound from impaction of vibrators and the steel reinforcement and steel formworks.

#### ⑥ Noise control in transportation

i ) Noise from the transportation of materials and equipment on site shall be limited via implementation of noise control measures. The equipment adopted for transportation shall meet the requirement of sound emission.

ii ) Mechanical lifting or manual handling measures shall be adopted for the dismantling/removing for the materials such as reinforcement, steel pipes, meal components, steel formwork, etc.

iii ) Handle with care when stacking materials which is easy to sounding so as to prevent from making big noise. No materials to be thrown and/or stacked from high.

iv ) Noise shall be tested and recorded, it can be done either by the construction team via their own or the rent equipment or by professional testing agency via authorize from construction team.

Special protective measure (such as soundproof working place) shall be adopted as well as making special plan and set up a special fund. Environment friendly tools (such as vibrators) could be used for soundproof cover.

## **SOLID WASTE CONTROL**

### (1) Classification of solid waste

#### ① Non-toxic, harmfulness and valuable waste

- i ) waste steel, waste wood, waste nonferrous metals;
- ii ) Packing boxes, buckets and bags for materials and equipment;
- iii) Waste electrical materials, waste accessories of mechanical metals;
- iv) Waste buildings as well as the bricks, tiles, doors and windows, etc.
- v ) Disused office supplies;
- vi) Waste decoration materials;
- vii) Materials;

#### ② Non-toxic, harmfulness and not valuable waste

- i ) Disused construction waste;
- ii ) Waste broken bricks, broken stones.
- iii) Domestic waste;

#### ③ Toxic and harmful

- i ) Waste fluorescent tubes, batteries, accumulators;
- ii ) Discarded ball-point pen refill, calculator;
- iii) Waste carbon paper, photographic film, cingulate;
- iv) Waste cartridges, disks, selenium drum;
- v ) Waste rubber, plastic products;
- vi) Discard toxic and harmful chemical packaging;
- vii) Waste oil drums, drums for chemical additives;

### (2) Collection and storage of solid waste

① Set up stack yard or containers for solid waste prior to the commencement of the construction work. Rainproof facilities shall be established for the waste which is easy to pollute the environment when wet by the rain.

② The solid waste staked on site shall be categorical in accordance with the marked labels, toxic or non-toxic shall be separated stored.

③ Hazardous and toxic waste shall not be stored together with non-toxic and harmless waste.

④ The stacking of solid waste shall be neat, reasonable and in compliance with the requirements of the construction civilization on site.

⑤ The solid waste collection shall be confirmed by the foreman via the work arrangement, and specialist shall be arranged for daily management.

(3) Disposal of solid waste

① The solid waste shall be treated by the personnel who is in charge of waste disposal management according to the amount of waste storage and storage place arrangements, report shall be submitted to the Project Manager when the storage is overloaded, the site civilized construction image is affected by the waste or the project is going to be completed in short time.

② The Project Manager shall review the disposal report submitted by the personnel in charge of waste dispose and he shall then report to the company's material department. After got the approval of the company, a disposal team shall be set up to deal with the solid waste which contains the staffs of material department and the man in charge of waste management.

③ Solid waste shall be classified according to the toxic properties and then be treated, combined treatment shall be prevented.

④ For non-toxic, harmless and valuable solid waste, if it is re-useable in other projects, recycling suggestions and responsible recycling department shall be reported to the material dept. and construction dept. Business certificated agency shall recycle it when the solid waste is uselessness.

⑤ For non-toxic, harmfulness and not valuable waste, sanitation department shall be entrusted to clean up it.

⑥ For the toxic and hazardous solid waste, entrust companies who is qualified with hazardous substances business license with it.



## **CONTROL OF WATER POLLUTION**

- (1) Sources of pollution: Muddy water from construction, water from flushing vehicles, sewage water from construction staffs, and surface water in the monsoon.
- (2) Control measures and requirements:
  - ① Wastewater discharged in to nature water, suspended solids (SS) follow the standard 150 mg/L of grade II in "Integrated Wastewater Discharge Standard" (GB8978-1996)
  - ② Choosing of location and method of discharging shall be in accordance with the trend and overload capacity of the drainages in various construction areas.
  - ③ Complete the drainage system and wastewater treatment plant prior to the commencement of the work, make sure their effectiveness during the whole construction period to get no ponding at site, no overflow, no block so as to enable the water quality meet the requirements.
  - ④ The size of the stockpile of backfilling earth and sedimentation tank of muddy water shall on basis of the sediment time required.
  - ⑤ Water discharging Emergency plan of monsoon, especially the heavy rain period which is for the purpose to prevent water pollution accident from wastewater discharged unorganized, overflow or block the sewer of city, shall be made and implement when required on basis of the practical construction situation and considering of rainfall characters of Khulna City.
  - ⑥ Exclusive oil storage shall be set up on site, anti-seepage treatment shall be made to the floor of the storage to prevent the oil from drop/leakage and/or pollute the soil and water.

## **AIR POLLUTION**

- (1) Sources of pollution: transportation, excavation, fuel machinery, stoves and so on.
- (2) Impact: dust (during preparation and excavation construction stage), dust, waste gas (during the whole construction period).
- (3) Control measures and requirements:
  - ① It is forbidden to burn down any waste and other materials which may produce toxic and hazardous gases, soot and bad smell while burning. Toxic material such like melting-asphalt shall be used cooperatively with the sealable equipment with soot treatment plant.
  - ② Commercial concrete shall be used for the Project.
  - ③ Cement and other materials which is easy to blow away shall be stored in the warehouse. Spoil pit, outdoor stockpile of loose material shall be covered and compacted.

- ④ Qualified transportation equipment shall be adopted so as to ensure nothing drop while transporting.
- ⑤ Stoves used shall meet the soot emission requirements.
- ⑦ The construction site shall be well planned and arranged prior to the commencement of the work, foundation of temporary construction road shall be compacted and the road shall be harden.

#### **ACCESS ROADS CONSTRUCTION**

- The existing Embankment is being intensively used by the locals, therefore the contractor will also use the same as access road for the construction of embankment.
- The Cofferdam for DS/FS excavation will be used as common access road for both public and construction activities. The typical drawing of cofferdam is attached for reference (Annex 6).
- The fences and other elements that define and provide access to farms will be moved and put back in the state they were found in.
- Box culverts will be constructed when required for crossing water bodies.

#### **SANITATION**

- The construction camps and all work sites will be provided with hygienic sanitation facilities (with proper water seal) for the workforce.
- The location of the latrines will be at least 50 meters away from the accommodation facility and will be located at a safe distance from any water body.
- Latrine will be installed in an elevated place to avoid the contact of tidal water.
- All latrines both in work site and camp site will be facilitated with proper door, roof, hand washing arrangement near the toilet (i.e. bucket with adequate water supply, hand washing liquid or soap, tissue, etc.)
- Separate latrines will be reserved for use by women.
- Treatment facilities (i.e., septic tank, soak pits, etc.) will be installed for sewerage of toilet and camp site wastes.
- Emptying facility of septic tank will be ensured within the specific design period of time.
- All discharges from toilets will be piped to a proper designed sewage treatment facility prior to discharge to a natural watercourse.
- Wastewater from washrooms, kitchens, etc., will be disposed via the camp area's drainage system.
- Toilet blocks will be properly cleaned and disinfected on a daily basis.

- **Safety and Health Policy**

- ✓ CICO believes that **no job or no task is more important than worker health and safety.**
- ✓ If a job represents a potential safety or health threat, every effort will be made to plan a safe way to do the task. Every procedure must be a safe procedure. If a worker observes any unsafe condition, which may pose a potential threat to their health or safety, it is expected that employees will immediately correct the situation when feasible or inform management. Management has the responsibility to take adequate precautions, and assure the safety and health of employees.
- ✓ **If a job cannot be done safely it will not be done.**
- ✓ All employees will be provided equally high quality safety and health protection. We acknowledge the importance of creating a positive safety culture through employee involvement and effective policies and procedures.

- **Safety and Health Objectives**

CICO plans to achieve worker safety and health through the following:

- ✓ Designate a qualified safety person to coordinate the program.
- ✓ Make regular job site safety inspections and conduct health monitoring.
- ✓ Follow safety procedures and rules.
- ✓ Provide on-going safety training.
- ✓ Enforce safety rules and use appropriate discipline.

- **Designated Safety Coordinator**

CICO has designated Safety Coordinator/ EHS in Charge. Mr. Chen Haibo is working in this site. His responsibilities include:

- a) Understand potential job hazards and how to eliminate them.
- b) Conduct or assist with Job Safety Analysis.
- c) Assure compliance with construction safety and health standard requirements.
- d) Conduct regular job site safety and health inspections.
- e) Establish safety and health procedures.
- f) Coordinate regular safety and health training.
- g) Conduct or assist with Tool Box Talks or Five Minute Safety Talks.
- h) Maintain documentation of training, inspections, injuries and illnesses, and other safety records.

Participate in accident investigations and implementation of corrective actions.

Create statistical reports that compare severity and frequency rates against prior records.

- **Safety and Health Team**

Our management will take an active role on the safety and health team. At least annually the safety and health team will develop written safety and health goals and track monthly progress. These goals will be communicated to all employees. Our team will be comprised of management and hourly employees. The team consists following persons:

- |                                |                   |
|--------------------------------|-------------------|
| I. Acting Project Manger       | -Convener         |
| II. EHS in Charge of CICO      | -Member Secretary |
| III. Respective Polder Manager | - Member          |
| IV. Chinese EHS Manager        | -Member           |
| V. Transport in Charge         | -Member           |
| VI. Local EHS Officer          | -Member           |

- **Responding to Safety and Health Issues**

- ✓ Address safety and health issues.
- ✓ Record and post minutes of the meetings.
- ✓ Involve employees in problem solving.
- ✓ Document action taken and post on the bulletin boards for all employees to read and-or comment.
- ✓ Have a formal agenda.
- ✓ It needs to be mentioned here that our activities on health and safety will be supervised and monitored by a Health and Safety Team composed by Environmental Specialist of PMU, DDCS &PMS Consultants and Third Party M&E Consultants

- **Safety Inspections**

Our employees will participate in regular safety and health inspections to help identify potentially hazardous conditions and unsafe actions and initiate corrections. Findings will be presented to for review. Corrective action will be implemented in a timely manner.

- **Employee Report of Hazards**

Our employees play a key role in identifying, controlling, and reporting hazards that may occur or already exist in the workplace. Employee reports of potential hazards can be an effective tool to trigger a closer look at a piece of equipment, operation, or how work is being performed. Reports of potential hazards can also provide suggestions to eliminate a hazard.

- **Accident/Incident Investigation**

All accidents resulting in injury or property damage will be investigated. The purpose of the investigation is not to find fault, but to find the cause of the accident so similar incidents can be prevented in the future.

- ✓ All accidents, no matter how minor must be reported to the Foreman immediately.
- ✓ Foremen must report all accidents to the Safety Coordinator as soon as possible.
- ✓ Foremen must complete an initial written accident investigation the day of the accident, if possible.
- ✓ All workers involved in the accident or who witnessed the accident must complete a written statement describing the incident.

- ✓ The Safety Coordinator will complete a thorough accident investigation to determine root causes and corrective actions.

- **HAZARD PREVENTION AND CONTROL**

Job site inspections will be conducted daily. Hazards will be documented, reviewed, and corrections will be made in a timely manner. More detailed, written inspections will be conducted on monthly basis. The Safety Coordinator or other designated safety person will tour each job site and observe potential safety/health hazards, and develop a plan for safeguarding this company's workers which may include the following:

- ✓ Removing the hazard.
- ✓ Guarding against the hazard.
- ✓ Providing personal protective equipment and enforcing its use.
- ✓ Training workers in safe work practices.
- ✓ Coordinating protection of workers through other contractors.

- **POLICIES, PROCEDURES, SAFETY AND HEALTH RULES**

Our management is responsible for implementing major decisions, policies and safety and health procedures. Specific safety and health procedures will be put in writing such as: lockout, right to know, fall protection, confined space, respiratory program, etc. A copy of our written safety program will be available on every polder jobsite, either in the jobsite trailer, the gang box, or with the foremen. We will inform and enforce the following safety rules:

**All of our safety rules must be obeyed. Failure to do so will result in strict disciplinary action.**

1. Wear appropriate clothing and vest.
2. Watch where you are walking. Do not run. Keep your mind on your work at all times.
3. Keep your working area free from rubbish and debris. A clean job is the start of a safe job.
4. Do not use a compressor to blow dust or dirt from your clothes, hair, or hands.
5. Report any fear of walking at heights to your supervisor.
6. Know where fire extinguishers are located and how to use them.
7. Keep back at least 10m from all power lines, further if high voltage.
8. Nobody but the operator shall be allowed to ride on equipment.
9. Do not use power tools and equipment until you have been properly instructed in the safe work methods and become authorized to use them.
10. Do not remove, displace, damage, or destroy any safety device or safeguard on equipment or machinery.
11. Never oil, lubricate, or fuel equipment while it is running or in motion.

Before servicing, repairing, or adjusting any powered tool or piece of equipment, disconnect it, lock out the source of power, and tag it out.

Excavations over five feet deep must be shored or sloped as required.

### **Evaluation and Adjustment of Emergency Plan**

The Project Office shall organize the evaluation and conclusion on the following situations:

(1) After the Emergency maneuver plan but not more than one week.

(2) Not more than a week after investigation and conduction completed when potential accident and/or emergency situation occur. The evaluation shall be organized by the Quality Control Dept. of the Project Office and the personnel involved in the accident shall be present.

The evaluation shall contain the comments on the reasonability, measure of rescue and implementation effective, suggestion on improvement shall be given at the same time.

## **Annex-20: Construction Traffic Management Plan**



## 1. Introduction

This Construction Traffic Management Plan (CTMP) describes how the Contractor, Chongqing International Construction Corporation (CICO), proposes to safely manage vehicle and pedestrian traffic during implementation of the Coastal Embankment Improvement Project, Phase-1, so that project objectives are fully realized.

CICO acknowledges the safety of road users and the effective management of traffic is paramount to the successful day-to-day activities during the construction phase of this Project. This CTMP seeks to ensure the certainty of the delivery of the prescribed road user requirements including: provision of a safe environment for workers and the travelling public and minimizing impacts on the road network.

This Plan operates as the master document to a set of sites or zone-specific Traffic Management Plans (TMP) and their associated Traffic Control Plans (TCP) and Temporary Works Drawings. Together they deal with the safe and effective management of traffic during the design and construction phase of the Project.

This CTMP is applicable to all staff, employees, subcontractors, and any statutory service authorities undertaking service relocations throughout the duration of the Contract until project completion and its implementation and on-going development will be managed by the Project Management team headed by Acting Project Manager of CICO.

### 1.1 Purpose

The intended purpose of the CTMP is to describe how the Contractor will implement the work in accordance with the requirements of the Project.

### 1.2 Scope

This Plan applies to all parts of the construction of the Works namely, manufacturing of CC blocks, up gradation/re-sectioning of the embankment, construction/repairing of drainage sluices and flushing sluices, slope as well as river bank protection, khal excavation etc. It does not apply to the maintenance of the road after opening to traffic. The scope includes:

- The provision for the safe movement of vehicular and pedestrian traffic.
- The protection of workers from passing traffic.
- The design, construction, maintenance and removal of any necessary temporary roadways and detours.
- The provision of traffic controllers.
- The installation of temporary signs, warning devices, lighting and safety barriers.

### 1.3 Project Description

The Coastal Embankment Improvement Project is a project building and engineering works designed by the Employer, which involves upgrading via new construction and re-sectioning of embankments, excavation and re-excavation of drainage channels in the Polders, construction of 50 drainage sluices, repairing of 6 drainage sluices, construction of 73 flushing sluices, repairing of 6 flushing sluices, construction of embankment slope protection works, construction of river bank protection works, construction of 8 khal closing closures



with varying widths, dismantling of 36 drainage sluices, 71 flushing sluice and road pavement, construction of RCC flood wall and construction of road pavement. The aims of the Project are to reduce the risk of flood, keep the residents and their properties safe within the Polders, prevent salinization of soil and underground water, storm surge, breach and cyclones.

#### 1.4 Background

The polders were originally designed without much attention to storm surges. Recent cyclones caused substantial damage to the embankments and threatened the integrity of the coastal polders. In addition to breaching of the embankment due to cyclones, siltation of peripheral rivers surrounding the embankment caused the coastal polders to suffer from water logging, which led to environmental, social and economic degradation. Poor maintenance and inadequate management of the polders have also caused internal drainage congestion and heavy external siltation. As a result, soil fertility and agriculture production in some areas inside the polders are declining.

#### 1.5 Environmental Management Document System

The Project Environmental Management document system is described in the C-ESMP. This plan is part of CICO's environmental management framework for the Project. In accordance with the requirements, this Plan has been developed in consultation with Royal Haskoning DHV, Devcon, dpm, IWM, and DHI and also recommendations received from PMU Environment Social and Communication Unit (ESCU). Management measures identified in this CTMP will be incorporated into the Contractor's site or activity specific Environmental Work Method Statements (EWMS). EWMSs will be developed and signed off by environment and management representatives prior to associated works and construction personnel will be required to undertake works in accordance with the identified safeguards. Used together, the C-ESMP, sub-plans, strategies, procedures and EWMS form management guides that clearly identify required environmental management actions for reference by the Contractor.

##### Key Issues

This CTMP addresses the following Key Issues and Processes identified within the document:

- Safety and amenity of road users and the public;
- Site security, site access and signage;
- Project identification, including project information and site signage;
- Traffic and road user delay and inconvenience management;
- Speed limit signage;
- Traffic transfer (switch) arrangements and procedures;
- Traffic and Safety Management Responsibilities;
- Construction staging including detailing the intersection layout and capacities for each and every construction stage; and
- Emergency and Incident Response Plans.

The Table below shows the risks to be dealt with during the design and construction stage of the Project that may affect safety:

Risks	Potential consequences	Proposed risk treatment
Construction methods may cause disruption to traffic.	Traffic delays causing frustration to drivers.	Consider methods of construction at an early stage during the design to reflect community needs and reduce delay times therefore minimizing the impact on traffic.
Traffic management-inadequate anticipation and communication of issues.	Potential community issues causing dissatisfaction and frustration.	<ul style="list-style-type: none"> <li>▪ Determine traffic routes and engage with community to refine details.</li> <li>▪ Confirm pre-existing conditions.</li> <li>▪ Consider the need for night assessment.</li> <li>▪ Identify any short-term corrective actions.</li> </ul>
Severe delays to traffic perceived by the community as a direct result of the construction activities.	Community dissatisfaction, claims for loss of trade, time delays.	<ul style="list-style-type: none"> <li>▪ Establish good public relations from the outset.</li> <li>▪ Erect Early Warning information signs through Variable Message Signs (VMS).</li> <li>▪ Early engagement of affected property/business owners to explain process and ascertain needs and potential effects of changed access.</li> </ul>
Access for emergency services restricted.	Emergency vehicles and personnel unable to attend to an emergency situation.	Liaise with Emergency Services at an early stage to establish requirements and measures to be adopted in the Vehicle Movement Plan (VMP)
Major Traffic Incident.	Local traffic disrupted upsetting locals.	<ul style="list-style-type: none"> <li>▪ Regular checking of Traffic Management Plan implementation.</li> <li>▪ Have procedures in place for rapid recovery, keep locals informed.</li> </ul>
Access to site for deliveries.	Traffic disruption or interference.	<ul style="list-style-type: none"> <li>▪ Development of this Plan in conjunction with Community Communication Strategy- access points will be high risk locations and will need detailed consideration.</li> </ul>
Traffic Speed.	Works in multiple areas across the Project may result in intermittent speed changes that may frustrate road users.	Traffic to generally be reduced to 80kph speeds within construction zone. Construction zone to be full length of the Project. CTMP to consider simplifying traffic staging to avoid construction zone impacting on traffic.
Pedestrian access.	Potential disruption to progress causing pedestrians to not comply with pedestrian provisions.	Liaise closely with the relevant bodies from an early stage to ensure pedestrian access provisions are adequately addressed, well established and maintained.
Lowering speeds, when it is perceived unnecessary.	Poor public opinion and safety for workers if motorists start ignoring limits.	Appropriate design of traffic protection measures, intersections, alignments etc. to allow consistent speed limits, i.e., 80km/h where-ever possible.
Too many changed configurations.	Unfamiliarity causing potential confusion of road users that may cause traffic incidents.	Keep motorists on existing alignment for as long as possible. Effective use of VMSs for advanced notification and clear direction during any traffic flow adjustments.

Risks	Potential consequences	Proposed risk treatment
Inadequate provisions for break-downs during construction.	Traffic delay.	Design temporary break down bays. Consider temporary verges where possible during design of traffic staging.
Public or livestock entering work-site. Unauthorized access to site.	Traffic Incident.	Provide clear delineation and fencing. Educate community (farmers/neighbors, of Work Cover requirements etc.). "Neighbors induction".
Dangerous entry and exits to sites and properties.	Traffic Incident.	Ensure that entries and exits are designed to cater for expected traffic volumes and with respect to sight distances, acceleration and deceleration provision and clear advanced warning signage.
Seasonal traffic variations not allowed for	High volumes during holidays and weekends.	Consider seasonal volumes in programming works. Keep RMS informed and up to date. Be aware of reporting and notification requirements.
Reduced allowable movements	Traffic delay, confusion to commuters that may lead to an incident.	Implement effective community engagement strategies that will consider businesses, property owner's requirements.
Damage to local roads due to heavy vehicle movements.	Vehicle damage and potential incidents. Poor community and council relationship.	Allow for heavy vehicle movements in traffic staging and planning to ensure existing, temporary alignment and pavements are suitable during the construction period.

## 1.6 Traffic Management and Mitigation Measures

A range of environmental requirements and control measures are also identified in the EIA. Mitigation and management measures will be implemented to avoid, minimize or manage impacts to traffic. Specific measures and requirements to address impacts on traffic are outlined in the requirements accompanied with this Plan. Further details (if required/advised) on the key issues relating to traffic management will be included in this Plan.

## 1.7 Impact of Contractor's Heavy Construction Vehicles on Local Roads

Any damage resulting from the use of the identified local roads by the Project's heavy construction vehicles, aside from that resulting from normal wear and tear, will be required to be repaired, unless otherwise agreed by the relevant authority.

## 2. Objectives and Targets

In summary, the key objectives to be adopted by the project team with respect to the CTMP are to:

- Keep traffic delays to a minimum;
- Maintain satisfactory property access;
- Minimize disturbance to the environment;
- Ensure the safety of the Employees, the Consultants, the general public, pedestrians, and traffic;
- Design temporary road ways and detours when necessary;

- Meet the requirements of project specific Specification.

Progress against the nominated objectives will be continually assessed during the course of the project.

### **3. Traffic Management Responsibilities**

The project management team is responsible for all construction activities, including the implementation and maintenance of the various temporary traffic management arrangements and have the qualifications depicted under 'Traffic Controllers' of this Plan.

CICO's initial Project Team organizational structure is appended to the Project Management Plan (PMP) and overall roles and responsibilities are outlined in both PMP and the C-ESMP. Specific responsibilities for the implementation of construction traffic management are detailed below.

#### **Project/Construction/Engineering Managers**

The Project Managers are responsible for ensuring traffic management:

- Is properly planned, organized, directed and controlled?;
- Is properly resourced with people, equipment, facilities and systems?;
- Meets the requirements of the Contract;
- Complies with all other legislation; and
- Is achieving its objectives?

#### **Traffic Manager**

The nominated Traffic Manager (Polder Manger) will be required to have the delegated authority from, and responsibility to, the Project Managers for continuously monitoring the implementation and operation of all road occupancies to ensure that they are compliant with, including but not limited to:

- Monitoring and quantifying the durations of delays to the free flow of traffic;
- Monitoring, measuring and recording traffic queue lengths, including the maximum traffic queue lengths in each direction and the total occupancy or stoppage time;
- Maintaining and adjusting traffic control measures and devices to assist prevailing traffic flows, minimize lane and shoulder occupancies and any lost traffic flow capacity and minimize traffic flow delay durations and queuing;
- Monitoring of over-dimension heavy vehicle movements;
- Prepare and keep records of all road occupancies and records of all traffic flow delays and durations, traffic queue lengths and other related matters;
- Ensuring that processes and control systems needed are established, implemented and maintained;
- Arranging and approving training;
- Ensuring that the requirements of all the plans are properly implemented;

- Regularly reviewing the continuing suitability, adequacy, and effectiveness, of all the plans;
- Allocation of all resources required for the implementation of all the plans;
- Ensuring that control measures are maintained and that work-in-progress is inspected;
- Identifying training needs and arranging for employees to attend the training;
- Carrying out and recording weekly inspections and verifications to demonstrate compliance;
- Facilitating traffic awareness and giving toolbox talks to the site; and

The Traffic Manager (Polder Manager) or the delegates (Transport in-Charge) in absence of Polder Manger will be contactable at all times (7 days per week and 24hrs. per day) during the construction phase of the works to receive and answer traffic/incident related inquiries. Site Emergency contact list shall be located in the CICO Incident and Emergency Response Plan that will be displayed in the site office. Refer to the Incident and Emergency Response Plan for details concerning the managing of incidents and emergencies on the project.

The Traffic manager (Polder Manger) will have the authority to stop work on any activity if it is considered to be necessary to prevent traffic incidents, or to comply with the directions of the Engineer or Police.

#### **Traffic manager (Polder Manager)**

The Traffic Engineer will be required to have delegated authority from, and responsibility to, the Traffic Manager for:

- Implementing the Traffic Management Plan on site
- Ensuring the safe passage of traffic at all times
- Ensuring everyone on site is inducted and wears the appropriate approved clothing
- Driving through the site to inspect the traffic control layout, recording any deficiencies and the action taken to rectify them
- Report incident including public road way that are unrelated to the construction activity, near misses to Traffic Manager.

#### **Engineers Responsible for the Work Activity**

- Assist in the delivery of the road safety and traffic management objectives outlined in the Plan;
- Plan all work activities and identify the required traffic management arrangements to facilitate the works;
- Liaise with the Traffic Crews in the planning and implementation of the required traffic management arrangements;
- Prepare TCPs to facilitate the works and obtains approval from the Traffic Manager;
- Conduct regular inspections (including pre-starts) of traffic controls and VMPs and, where necessary, instruct the rectification of deficiencies;
- Allocate plant, equipment and human resources for the works including the provision

of the temporary traffic control arrangements; and

- Conduct and keep records of daily and weekly (day and night) inspections of the traffic control arrangements, assist audits and, where necessary, rectify deficiencies.

#### **Foreman**

- Ensure compliance to the approved TCPs;
- Issues the required TCPs and, where relevant, road occupancy approvals and speed zone authorizations to the traffic control crew;
- Ensures adequate plant, equipment and human resources are made available for the installation and maintenance of temporary control devices;
- Conducts pre-start inspections and regular night/ weekly inspections of traffic control arrangements, and ensure all deficiencies are rectified;
- Assist with the implementation of mitigation measures to address unsafe road conditions, and unusual traffic congestion;
- Assist with the management of unplanned incidents, providing initial response to make the site safe; and
- Records unplanned incident details, and when traffic controls are in operation, including the installation and removal of regulatory signage.

#### **Functional Personnel**

- Functional personnel provide support for all construction activities and their traffic management related responsibilities are described above; and
- WHS team is responsible for managing haulage routes in compliance with WHS Management Plan.

#### **Community Relations Manager**

- Liaises with the community for all aspects of community issues;
- Represents the Project for all community issues;
- Conducts consultation for traffic planning, and provides an on-going liaison role;
- Prepares and distributes changed traffic condition information to the community; and
- Community relations including addressing complaints.

#### **4. Measures that CICO will use to deliver public safety include:**

- Providing separation between the public and the works. This is a key element to providing safety to road users and the construction team. This will be done through the use of barriers, haul roads, side tracks, staging works and road side furniture such as approved safety barriers to provide sufficient separation and safety measures to minimize the impact of the works.
- Implementing specific traffic management measures only where absolutely necessary to reduce traffic speed, volumes and alignment to provide safety to both construction crews and the public;
- Limiting the working hours/vehicle boarding (before 7.00 am & after 5.00 pm) and

works (movement of vehicle) that could pose substantial impact on road users and the public;

- Minimizing disruption during peak traffic periods, public holiday weekends and school holidays by limiting the extent of traffic management undertaken during these times;
- Providing and maintaining public access to affected properties, farms and agricultural crossings/tracks, and recreational areas. VMPs will be developed for specific areas that require work access restrictions to maintain public access.
- Designing the works to minimize the number of construction site entry and exit points and providing traffic control to avoid traffic conflicts and minimize delays;
- Implementation of visual barriers to reduce potential distraction of road users;
- Community consultation and notification to keep road users and the public up to date regarding traffic management measures or restrictions; and
- Avoiding the hazardous movements.

To provide a safe environment for pedestrians, the Traffic Manager will clearly define the boundaries of all work areas, and provide defined walking paths, where required.

Where the work areas restrict access to existing footpaths, we will be required to develop and implement alternative routes and facilities.

This will be initiated through community engagement to confirm any specific requirements or suggestions that they may have regarding any changes required.

Alternative routes may include using the opposite footpath or detours via other streets. Alternative facilities may include footpath protections such as barriers or a speed reduction to ensure adherence to minimum lateral clearances to traffic or provision of temporary footpaths through the work area.

All temporary footpaths will be required to be:

- Clearly defined;
- Signposted appropriately to indicate the direction of the footpath;
- Constructed of an all-weather surface, free of trip hazards;
- Designed to accommodate the type of pedestrians to be encountered within the area;
- Provided with pram ramps, hand rails and street lighting where required;
- The minimum width specified by the road authority; and
- Kept well maintained while in operation.

In locations where pedestrians are diverted onto the existing roadways adjacent to traffic flows, additional treatments will be required to be implemented by us to ensure adequate safety separation is provided and that it is clearly delineated.

## **5. Emergency and Response to Incidents**

CICO will provide traffic control by qualified traffic controllers for emergencies such as crashes and spillages along the work corridor. The types of emergencies / unplanned incidents that may occur include, but are not limited to:

- Motor vehicle crashes;

- Bush fires;
- Environmental spills;
- Terrorist attacks;
- Bomb threats;
- Construction type incidents;
- Structural catastrophic failures;
- Inclement weather conditions;
- Flooding; and
- Anti-social behaviour.

The inevitable nature of emergencies and their potentially significant social, economic and environmental consequences is acknowledged and relevant state acts and legislation have been enacted to controlling these situations. The relevant acts identify agencies primarily responsible for controlling particular hazards/emergencies.

In the event of a traffic accident occurring within the construction site or at other locations affected by the works, the Project team will record the knowledge of the facts and photograph the approach to the accident site including the location of all safety devices and signs as soon as possible after the accident. A report with this information must be forwarded to the Engineer within 2 days of the occurrence of the accident.

## **6. Emergency Services**

The Community Relations Manager and the WHS Manager will be responsible for providing up to date information to the respective emergency services regarding any changes or restrictions to traffic flows during the project. The wider project team will be responsible for adhering to these requirements and notifying the Community Relations Manager and Safety Manager of any restrictions or changes as required.

Arrangements to manage impacts on emergency services include:

- Notification and communication with affected emergency services in accordance with the Community Communication Strategy;
- Updating the project team and work crews of any requirements or measures to be undertaken to enable access through site in conjunction with emergency services;
- Notification of out of hours works or works that may restrict access including suggested detour routes;
- Provision for emergency service access through construction zones and subsequent notification to emergency services of any changes to these conditions;
- Communication with the project workforce to ensure understanding of emergency access and response requirements.
- Training of staff to ensure understanding of expectation and requirements.

The Traffic Manager or the delegates will then be required to contact the relevant incident controller in accordance to the project's Incident and Emergency Response Plan.

## **7. Methods of Reporting**



The methods of reporting to be applied by the project team will be as follows:

- Verbal reports - on issues of an urgent nature, (e.g. initial reporting of major unplanned incidents, adverse community/political feedback) which will be followed up with a formal written report;
- Formal written reports - in a format subject to Engineer or Employer needs;

## **8. Monitoring and Inspections**

In addition to the inspections conducted by the Engineer, one nominee is required to inspect the temporary traffic controls during the construction phase, focusing on monitoring compliance against the TCP/VMP and identifying safety hazards, to enable implementation of corrective solutions.

The Traffic Manager, or delegate, will be required to conduct four main types of inspections:

- Daily pre-start and pre-close down inspections of short-term traffic control;
- Weekly inspections of long-term traffic control;
- Night inspections of long-term traffic control; and
- Pre-opening inspections of minor temporary traffic switches.

## **Annex-21: Site Organ gram**

A complete & updated organogram including Chinese EHS manager as well as Local EHS officer for all six Polders under contract Package W-02 is shown herewith:

